

FAG

★ QJ317-N2-MPA

Four-point contact bearing

Schaeffler ID:
0192623100000Four point contact bearing QJ3..-N2-MPA,
holding grooves, solid brass cage

★ Preferred product

Technical information

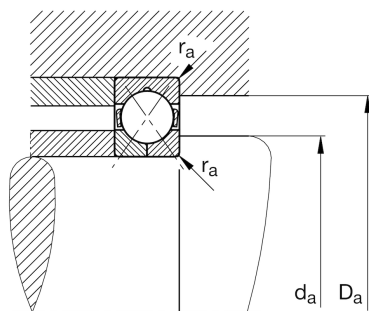
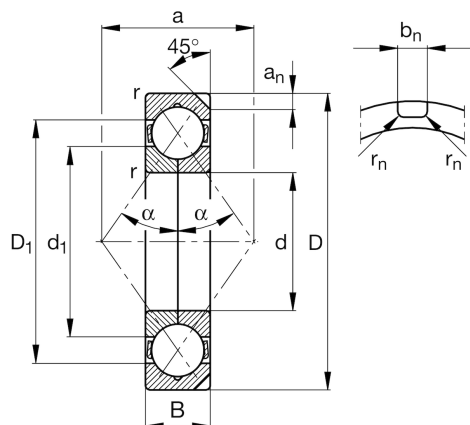

Temperature range

T_{\min}	-30 °C	Operating temperature min.
T_{\max}	150 °C	Operating temperature max.
	5,362 kg	Weight

Main Dimensions & Performance Data

d	85 mm	Bore diameter
D	180 mm	Outside diameter
B	41 mm	Width
C_r	248.000 N	Basic dynamic load rating, radial
C_{0r}	255.000 N	Basic static load rating, radial
C_{ur}	12.800 N	Fatigue load limit, radial
n_G	6.600 1/min	Limiting speed
n_{gr}	3.550 1/min	Reference speed

Dimensions

r_{\min}	3 mm	Minimum chamfer dimension
D_1	148,7 mm	Shoulder diameter outer ring
d_1	117,9 mm	Shoulder diameter inner ring
a	93 mm	Distance between the apices of the pressure cones
a_n	11,7 mm	Height retaining slot
b_n	10,5 mm	Width retaining slot
r_n	2 mm	Radius retaining slot
	45 °	Angle retaining slot
α	35 °	Contact angle

Mounting dimensions

$d_{a \min}$	99 mm	Minimum diameter shaft shoulder
$D_{a \max}$	166 mm	Maximum diameter of housing shoulder
$r_{a \max}$	2,5 mm	Maximum fillet radius