

FAG

B7034-C-T-P4S-UL

Spindle bearing

Schaeffler ID:
0191530740000Spindle bearings B70...-C, adjusted, in pairs or sets, contact angle $\alpha = 15^\circ$, restricted tolerances

Technical information

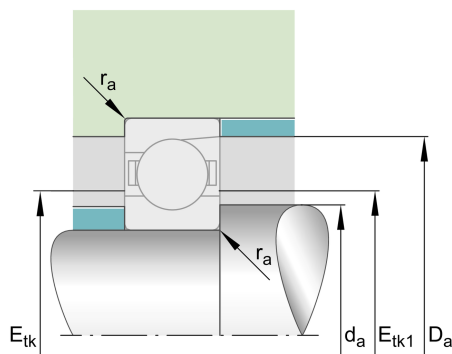
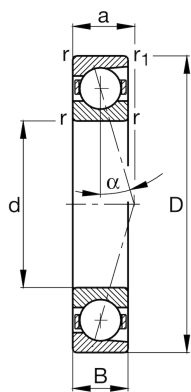
**Temperature range**

T_{\min}	-30 °C	Operating temperature min.
T_{\max}	100 °C	Operating temperature max.
	6,41 kg	Weight

Main Dimensions & Performance Data

d	170 mm	Bore diameter
D	260 mm	Outside diameter
B	42 mm	Width
C_r	241.000 N	Basic dynamic load rating, radial
C_{0r}	189.000 N	Basic static load rating, radial
C_{ur}	13.700 N	Fatigue load limit, radial
$n_{G \text{ Grease}}$	5.300 1/min	Limiting speed for grease lubrication
$n_{G \text{ Oil}}$	8.000 1/min	Limiting speed for oil lubrication

Dimensions

r_{\min}	2,1 mm	Minimum chamfer dimension
$r_{1 \min}$	2,1 mm	Minimum chamfer dimension
α	15 °	Contact angle



Mounting dimensions

d_a	185 mm	Diameter shaft shoulder
d_a	h12	Diameter shaft shoulder clearance
D_a	246 mm	Shoulder diameter outer ring
D_a	H12	Shoulder diameter outer ring clearance
$r_{a \max}$	2,1 mm	Maximum recess radius
$r_{a1 \max}$	1 mm	Maximum recess radius
$E_{tk \min}$	195,9 mm	Minimum diameter injection pitch
$E_{tk \max}$	206,9 mm	Maximum diameter injection pitch
$E_{tk1 \min}$	195,9 mm	Minimum diameter injection pitch
$E_{tk1 \max}$	206,9 mm	Maximum diameter injection pitch
a	49,8 mm	Distance between the apexes of the pressure cones

Additional information

F_{VL}	1.448 N	Preload force light
F_{VM}	4.488 N	Preload force medium
F_{VH}	8.919 N	Preload force heavy
K_{aEL}	4.439 N	Lift-off force light
K_{aEM}	14.768 N	Lift-off force medium
K_{aEH}	31.222 N	Lift-off force heavy
c_{aL}	171 N/ μ m	Axial rigidity light
c_{aM}	282 N/ μ m	Axial rigidity medium
c_{aH}	397 N/ μ m	Axial rigidity heavy