

FAG

★ B71934-C-T-P4S-UL

Spindle bearing

Schaeffler ID:
0191554410000

★ Preferred product

Spindle bearings B719..-C, adjusted,
in pairs or sets, contact angle $\alpha = 15^\circ$,
restricted tolerances

Technical information

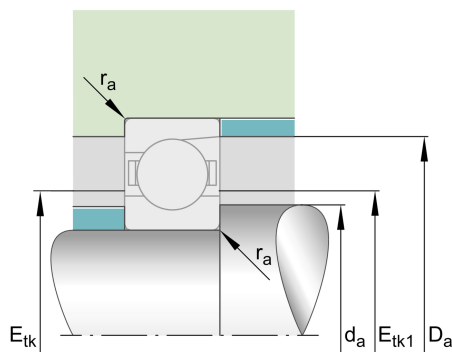
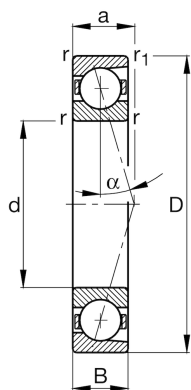

Temperature range

T_{\min}	-30 °C	Operating temperature min.
T_{\max}	100 °C	Operating temperature max.
	2,74 kg	Weight

Main Dimensions & Performance Data

d	170 mm	Bore diameter
D	230 mm	Outside diameter
B	28 mm	Width
C_r	133.000 N	Basic dynamic load rating, radial
C_{0r}	115.000 N	Basic static load rating, radial
C_{ur}	8.600 N	Fatigue load limit, radial
$n_{G \text{ Grease}}$	5.600 1/min	Limiting speed for grease lubrication
$n_{G \text{ Oil}}$	8.500 1/min	Limiting speed for oil lubrication

Dimensions

r_{\min}	2 mm	Minimum chamfer dimension
$r_{1 \min}$	1 mm	Minimum chamfer dimension
α	15 °	Contact angle



Mounting dimensions

d_a	180 mm	Diameter shaft shoulder
d_a	h12	Diameter shaft shoulder clearance
D_a	219 mm	Shoulder diameter outer ring
D_a	H12	Shoulder diameter outer ring clearance
$r_{a \max}$	1 mm	Maximum recess radius
$r_{a1 \max}$	1 mm	Maximum recess radius
$E_{tk \min}$	188,6 mm	Minimum diameter injection pitch
$E_{tk \max}$	194,7 mm	Maximum diameter injection pitch
$E_{tk1 \min}$	188,6 mm	Minimum diameter injection pitch
$E_{tk1 \max}$	194,7 mm	Maximum diameter injection pitch
a	40,8 mm	Distance between the apexes of the pressure cones

Additional information

F_{VL}	742 N	Preload force light
F_{VM}	2.375 N	Preload force medium
F_{VH}	4.770 N	Preload force heavy
K_{aEL}	2.266 N	Lift-off force light
K_{aEM}	7.779 N	Lift-off force medium
K_{aEH}	16.624 N	Lift-off force heavy
c_{aL}	154 N/ μ m	Axial rigidity light
c_{aM}	256 N/ μ m	Axial rigidity medium
c_{aH}	362 N/ μ m	Axial rigidity heavy