



FAG

★ B71912-E-T-P4S-UL

Spindle bearing

Schaeffler ID:
0191541780000

Spindle bearing B719...-E-T-P4S, with steel balls

★ Preferred product

Technical information

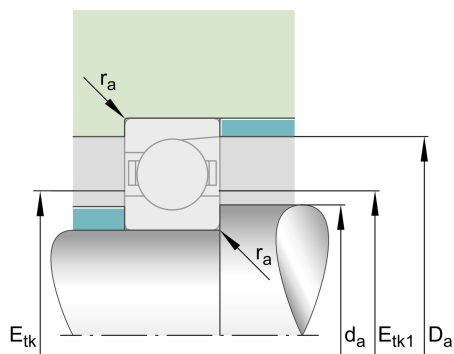

Temperature range

T_{\min}	-30 °C	Operating temperature min.
T_{\max}	100 °C	Operating temperature max.
	0,002 kg	Weight

Main Dimensions & Performance Data

d	60 mm	Bore diameter
D	85 mm	Outside diameter
B	13 mm	Width
C_r	23.400 N	Basic dynamic load rating, radial
C_{0r}	15.200 N	Basic static load rating, radial
C_{ur}	1.610 N	Fatigue load limit, radial
$n_{G \text{ Grease}}$	14.000 1/min	Limiting speed for grease lubrication
$n_{G \text{ Oil}}$	22.000 1/min	Limiting speed for oil lubrication

Dimensions

r_{\min}	1 mm	Minimum chamfer dimension
$r_{1 \min}$	1 mm	Minimum chamfer dimension
α	25 °	Contact angle



Mounting dimensions

d_a	65 mm	Diameter shaft shoulder
d_a	h12	Diameter shaft shoulder clearance
D_a	80,5 mm	Shoulder diameter outer ring
D_a	H12	Shoulder diameter outer ring clearance
$r_{a \max}$	0,6 mm	Maximum recess radius
$r_{a1 \max}$	0,3 mm	Maximum recess radius
$E_{tk \min}$	67,8 mm	Minimum diameter injection pitch
$E_{tk \max}$	70,1 mm	Maximum diameter injection pitch
$E_{tk1 \min}$	67,8 mm	Minimum diameter injection pitch
$E_{tk1 \max}$	70,1 mm	Maximum diameter injection pitch
a	23,4 mm	Distance between the apexes of the pressure cones

Additional information

F_{VL}	155 N	Preload force light
F_{VM}	617 N	Preload force medium
F_{VH}	1.344 N	Preload force heavy
K_{aEL}	448 N	Lift-off force light
K_{aEM}	1.853 N	Lift-off force medium
K_{aEH}	4.171 N	Lift-off force heavy
c_{aL}	124 N/ μ m	Axial rigidity light
c_{aM}	208 N/ μ m	Axial rigidity medium
c_{aH}	286 N/ μ m	Axial rigidity heavy