

FAG

★ B7211-E-T-P4S-UL

Spindle bearing

Schaeffler ID:
0191566770000

★ Preferred product

Spindle bearings B72...-E, adjusted, in pairs or sets, contact angle $\alpha = 25^\circ$, restricted tolerances

Technical information

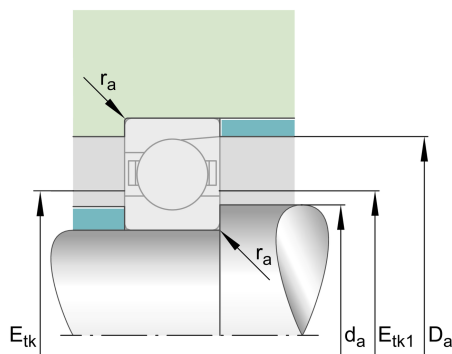
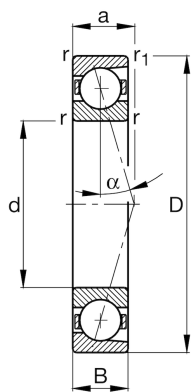

Temperature range

T_{\min}	-30 °C	Operating temperature min.
T_{\max}	100 °C	Operating temperature max.
	0,612 kg	Weight

Main Dimensions & Performance Data

d	55 mm	Bore diameter
D	100 mm	Outside diameter
B	21 mm	Width
C_r	45.000 N	Basic dynamic load rating, radial
C_{0r}	25.000 N	Basic static load rating, radial
C_{ur}	2.650 N	Fatigue load limit, radial
$n_{G \text{ Grease}}$	13.000 1/min	Limiting speed for grease lubrication
$n_{G \text{ Oil}}$	20.000 1/min	Limiting speed for oil lubrication

Dimensions

r_{\min}	1,5 mm	Minimum chamfer dimension
$r_{1 \min}$	1,5 mm	Minimum chamfer dimension
α	25 °	Contact angle

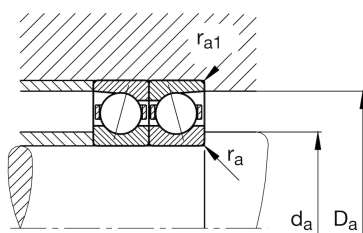

Mounting dimensions

d_a	63 mm	Diameter shaft shoulder
d_a	h12	Diameter shaft shoulder clearance
D_a	92 mm	Shoulder diameter outer ring
D_a	H12	Shoulder diameter outer ring clearance
$r_{a \max}$	1,5 mm	Maximum recess radius
$r_{a1 \max}$	0,6 mm	Maximum recess radius
$E_{tk \min}$	69,9 mm	Minimum diameter injection pitch
$E_{tk \max}$	74,3 mm	Maximum diameter injection pitch
$E_{tk1 \min}$	69,9 mm	Minimum diameter injection pitch
$E_{tk1 \max}$	74,3 mm	Maximum diameter injection pitch
a	28,6 mm	Distance between the apexes of the pressure cones

Additional information

F_{VL}	378 N	Preload force light
F_{VM}	1.321 N	Preload force medium
F_{VH}	2.767 N	Preload force heavy
K_{aEL}	1.103 N	Lift-off force light
K_{aEM}	3.991 N	Lift-off force medium
K_{aEH}	8.652 N	Lift-off force heavy
c_{aL}	155 N/ μ m	Axial rigidity light
c_{aM}	249 N/ μ m	Axial rigidity medium
c_{aH}	339 N/ μ m	Axial rigidity heavy