



FAG

## ★ N203-E-XL-TVP2

Cylindrical roller bearing

Schaeffler ID:  
0192171530000

★ Preferred product

Cylindrical roller bearing N2..-E-TVP, with cage, single row, non-locating bearing, 0 ribs on outer ring, 2 rib on inner ring, type N2

## Technical information

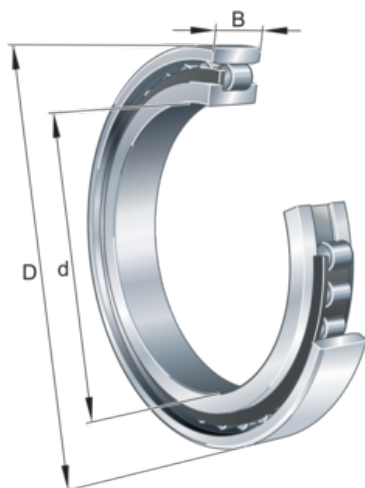
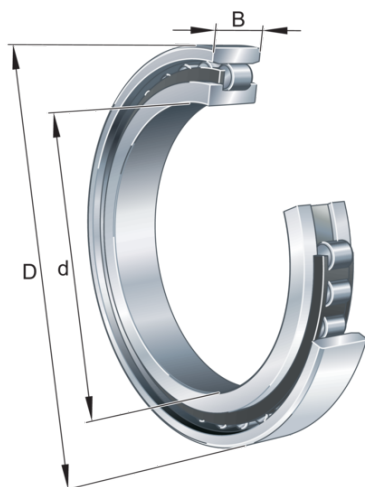
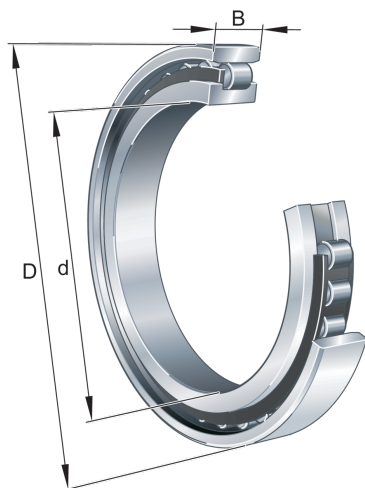

## Temperature range

$T_{\min}$	-30 °C	Operating temperature min.
$T_{\max}$	120 °C	Operating temperature max.
	0,068 kg	Weight

## Main Dimensions &amp; Performance Data

d	17 mm	Bore diameter
D	40 mm	Outside diameter
B	12 mm	Width
$C_r$	20.800 N	Basic dynamic load rating, radial
$C_{0r}$	14.600 N	Basic static load rating, radial
$C_{ur}$	2.230 N	Fatigue load limit, radial
$n_{G \text{ Grease}}$	19.500 1/min	Limiting speed for grease lubrication
$n_{G \text{ Oil}}$	22.900 1/min	Limiting speed for oil lubrication

## Dimensions

$r_{1 \min}$	0,3 mm	Minimum chamfer dimension
$s_1$	1,2 mm	Axial displacement
E	35,1 mm	Raceway diameter outer ring

## Mounting dimensions

$d_{a \min}$	21 mm	Minimum diameter shaft shoulder
$D_{a \max}$	36 mm	Maximum diameter of housing shoulder
$r_{a1 \max}$	0,6 mm	Maximum recess radius

