



FAG

★ N206-E-XL-TVP2

Cylindrical roller bearing

Schaeffler ID:
0192172180000

★ Preferred product

Cylindrical roller bearing N2..-E-TVP, with cage, single row, non-locating bearing, 0 ribs on outer ring, 2 rib on inner ring, type N2

Technical information

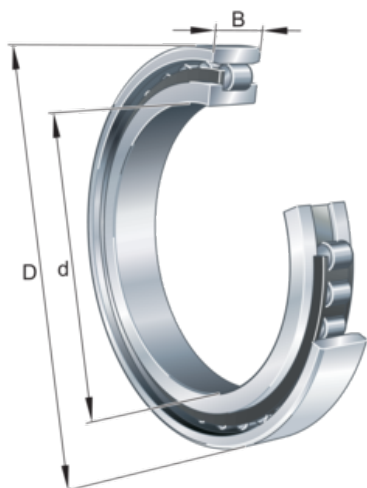
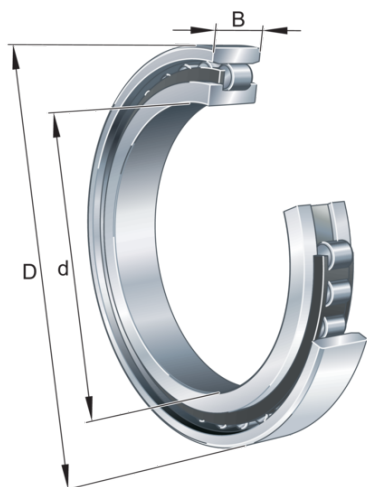
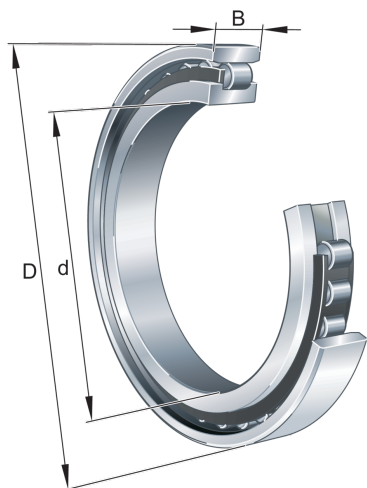

Temperature range

T_{\min}	-30 °C	Operating temperature min.
T_{\max}	120 °C	Operating temperature max.
	0,205 kg	Weight

Main Dimensions & Performance Data

d	30 mm	Bore diameter
D	62 mm	Outside diameter
B	16 mm	Width
C_r	46.000 N	Basic dynamic load rating, radial
C_{0r}	37.500 N	Basic static load rating, radial
C_{ur}	5.500 N	Fatigue load limit, radial
$n_{G \text{ Grease}}$	12.100 1/min	Limiting speed for grease lubrication
$n_{G \text{ Oil}}$	14.200 1/min	Limiting speed for oil lubrication

Dimensions

$r_{1 \min}$	0,6 mm	Minimum chamfer dimension
s_1	1,4 mm	Axial displacement
E	55,5 mm	Raceway diameter outer ring

Mounting dimensions

$d_{a \min}$	34 mm	Minimum diameter shaft shoulder
$D_{a \max}$	56 mm	Maximum diameter of housing shoulder
$r_{a1 \max}$	1 mm	Maximum recess radius

