



FAG

★ N208-E-XL-TVP2

Cylindrical roller bearing

Schaeffler ID:
0167337540000

★ Preferred product

Cylindrical roller bearing N2..-E-TVP, with cage, single row, non-locating bearing, 0 ribs on outer ring, 2 rib on inner ring, type N2

Technical information

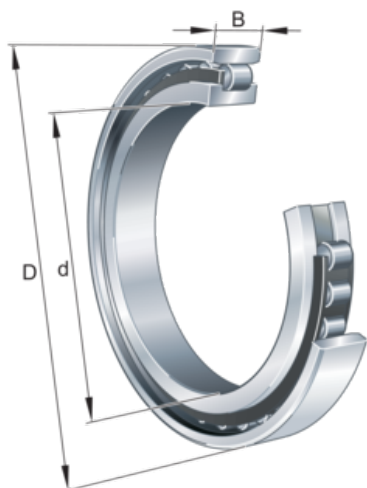
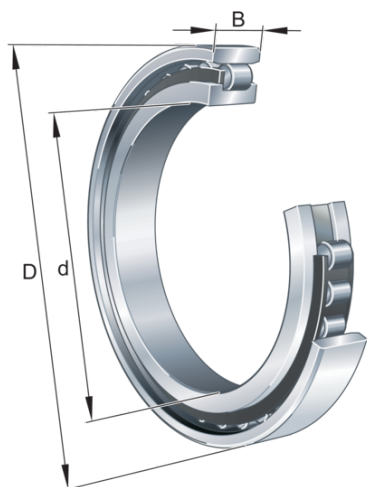
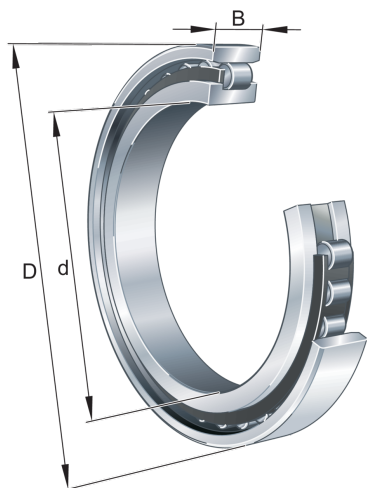

Temperature range

T_{min}	-30 °C	Operating temperature min.
T_{max}	120 °C	Operating temperature max.
	0,004 kg	Weight

Main Dimensions & Performance Data

d	40 mm	Bore diameter
D	80 mm	Outside diameter
B	18 mm	Width
C_r	63.000 N	Basic dynamic load rating, radial
C_{0r}	53.000 N	Basic static load rating, radial
C_{ur}	8.500 N	Fatigue load limit, radial
$n_{G Grease}$	9.300 1/min	Limiting speed for grease lubrication
$n_{G Oil}$	10.900 1/min	Limiting speed for oil lubrication

Dimensions

$r_{1 min}$	1,1 mm	Minimum chamfer dimension
s_1	1 mm	Axial displacement
E	71,5 mm	Raceway diameter outer ring

Mounting dimensions

$d_{a min}$	47 mm	Minimum diameter shaft shoulder
$D_{a max}$	73 mm	Maximum diameter of housing shoulder
$r_{a1 max}$	1 mm	Maximum recess radius

