

FAG

NNU4922-S-M-SP

Cylindrical roller bearing

Schaeffler ID:
0192328370000Super precision cylindrical roller bearings
NNU49..-S-M-SP, non-locating bearing,
double row, separable, with cage

Technical information

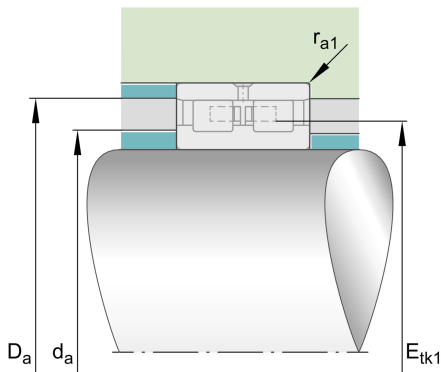
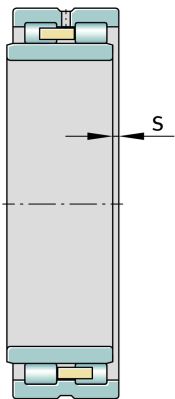
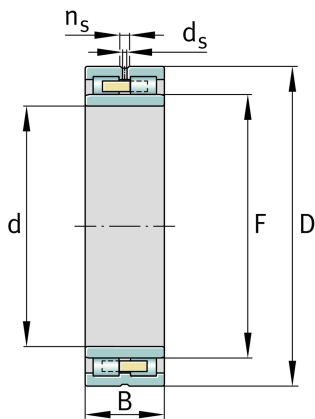
**Main Dimensions & Performance Data**

d	110 mm	Bore diameter
D	150 mm	Outside diameter
B	40 mm	Width
C_r	132.000 N	Basic dynamic load rating, radial
C_{0r}	270.000 N	Basic static load rating, radial
C_{ur}	35.000 N	Fatigue load limit, radial
$n_{G \text{ Grease}}$	5.400 1/min	Limiting speed for grease lubrication
$n_{G \text{ Oil}}$	6.300 1/min	Limiting speed for oil lubrication
	2,088 kg	Weight

Dimensions

$r_{1 \text{ min}}$	1,1 mm	Minimum chamfer dimension
F	123 mm	Raceway diameter inner ring
n_s	6,5 mm	Width of lubricating groove
d_s	3,2 mm	Diameter lubrication hole
s	2 mm	Axial displacement

Mounting dimensions

$d_{a \text{ min}}$	122 mm	Minimum diameter shaft shoulder
$D_{a \text{ max}}$	139 mm	Maximum diameter of housing shoulder
$r_{a1 \text{ max}}$	1 mm	Maximum recess radius

Temperature range

T_{min}	-30 °C	Operating temperature min.
T_{max}	150 °C	Operating temperature max.