

FAG

★ NNU4932-S-M-SP

Cylindrical roller bearing

Schaeffler ID:
0192331320000

★ Preferred product

Super precision cylindrical roller bearings
NNU49..-S-M-SP, non-locating bearing,
double row, separable, with cage

Technical information

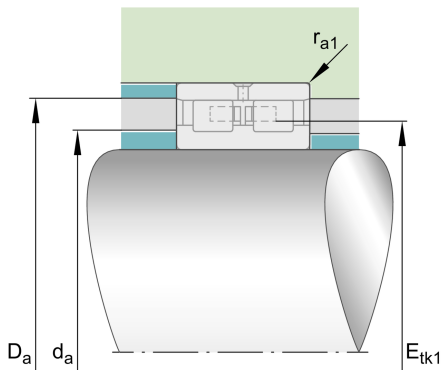
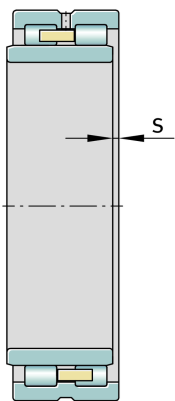
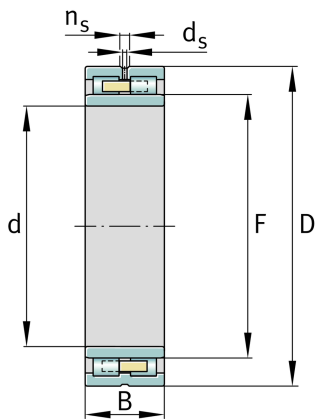

Temperature range

T_{\min}	-30 °C	Operating temperature min.
T_{\max}	150 °C	Operating temperature max.
	6,682 kg	Weight

Main Dimensions & Performance Data

d	160 mm	Bore diameter
D	220 mm	Outside diameter
B	60 mm	Width
C_r	335.000 N	Basic dynamic load rating, radial
C_{0r}	680.000 N	Basic static load rating, radial
C_{ur}	84.000 N	Fatigue load limit, radial
$n_{G \text{ Grease}}$	3.400 1/min	Limiting speed for grease lubrication
$n_{G \text{ Oil}}$	4.000 1/min	Limiting speed for oil lubrication

Dimensions

$r_{1 \min}$	2 mm	Minimum chamfer dimension
F	178,5 mm	Raceway diameter inner ring
n_s	6,5 mm	Width of lubricating groove
d_s	3,2 mm	Diameter lubrication hole
s	2,7 mm	Axial displacement

Mounting dimensions

$d_{a \min}$	177,2 mm	Minimum diameter shaft shoulder
$D_{a \max}$	206,5 mm	Maximum diameter of housing shoulder
$r_{a1 \max}$	2 mm	Maximum recess radius