

FAG

## ★ 22207-E1-XL

Spherical roller bearing

Schaeffler ID:  
0167033400000Spherical roller bearings 222...-E1, main  
dimensions to DIN 635-2

★ Preferred product

X-life

## Technical information

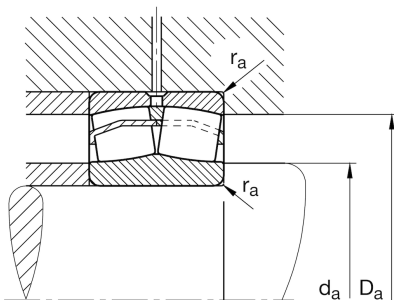
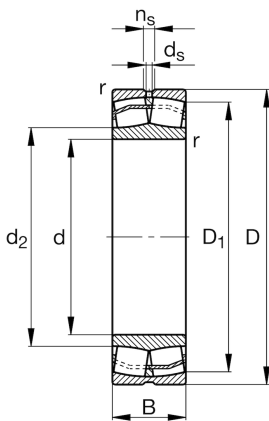

## Temperature range

$T_{min}$	-30 °C	Operating temperature min.
$T_{max}$	200 °C	Operating temperature max.
	0,423 kg	Weight

## Main Dimensions &amp; Performance Data

d	35 mm	Bore diameter
D	72 mm	Outside diameter
B	23 mm	Width
$C_r$	89.000 N	Basic dynamic load rating, radial
$C_{0r}$	81.000 N	Basic static load rating, radial
$C_{ur}$	9.700 N	Fatigue load limit, radial
$n_G$	10.700 1/min	Limiting speed
$n_{gr}$	7.000 1/min	Reference speed

## Dimensions

$r_{min}$	1,1 mm	Minimum chamfer dimension
$D_1$	62,5 mm	Bore diameter outer ring
$d_2$	43,9 mm	Raceway diameter of the inner ring
$d_s$	3,2 mm	Diameter lubrication hole
$n_s$	4,8 mm	Width of lubricating groove

## Mounting dimensions

$d_{a min}$	42 mm	Minimum diameter shaft shoulder
$D_{a max}$	65 mm	Maximum diameter of housing shoulder
$r_{a max}$	1 mm	Maximum recess radius

**Additional information**

e	0,31	Limiting value of Fa/Fr for the applicability of diff. Values of factors X and Y
Y <sub>1</sub>	2,21	Dynamic axial load factor
Y <sub>2</sub>	3,29	Dynamic axial load factor
Y <sub>0</sub>	2,16	Static axial load factor