

FAG

★ 23126-E1A-XL-M

Spherical roller bearing

Schaeffler ID:
0190308780000Spherical roller bearings 231...-E1A, main
dimensions to DIN 635-2

★ Preferred product

X-life

Technical information

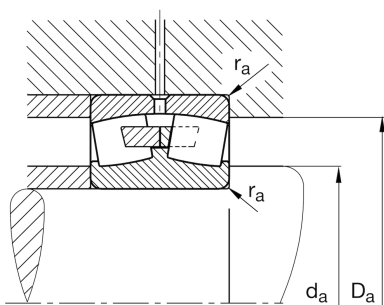
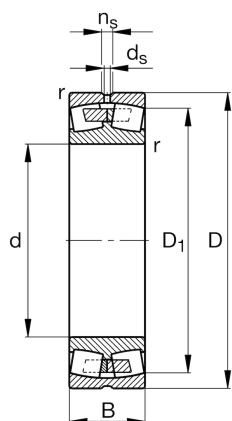

Temperature range

T_{\min}	-30 °C	Operating temperature min.
T_{\max}	200 °C	Operating temperature max.
	8,459 kg	Weight

Main Dimensions & Performance Data

d	130 mm	Bore diameter
D	210 mm	Outside diameter
B	64 mm	Width
C_r	680.000 N	Basic dynamic load rating, radial
C_{0r}	890.000 N	Basic static load rating, radial
C_{ur}	81.000 N	Fatigue load limit, radial
n_G	3.200 1/min	Limiting speed
n_{gr}	2.110 1/min	Reference speed

Dimensions

r_{\min}	2 mm	Minimum chamfer dimension
D_1	187,3 mm	Bore diameter outer ring
d_s	4,8 mm	Diameter lubrication hole
n_s	9,5 mm	Width of lubricating groove

Mounting dimensions

$d_{a\min}$	141 mm	Minimum diameter shaft shoulder
$D_{a\max}$	199 mm	Maximum diameter of housing shoulder
$r_{a\max}$	2 mm	Maximum recess radius

Additional information

e	0,28	Limiting value of Fa/Fr for the applicability of diff. Values of factors X and Y
Y ₁	2,45	Dynamic axial load factor
Y ₂	3,64	Dynamic axial load factor
Y ₀	2,39	Static axial load factor