



FAG

★ 23138-E1A-XL-M

Spherical roller bearing

Schaeffler ID:
0167078420000Spherical roller bearings 231...-E1A, main
dimensions to DIN 635-2

★ Preferred product

X-life

Technical information

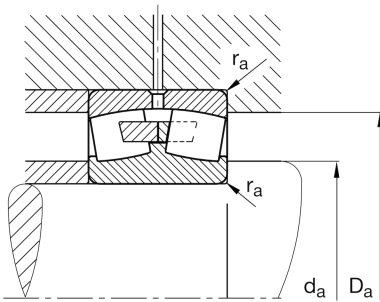
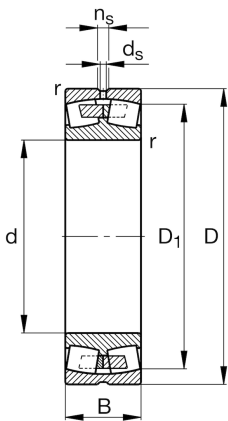

Temperature range

T_{\min}	-30 °C	Operating temperature min.
T_{\max}	200 °C	Operating temperature max.
	33,759 kg	Weight

Main Dimensions & Performance Data

d	190 mm	Bore diameter
D	320 mm	Outside diameter
B	104 mm	Width
C_r	1.610.000 N	Basic dynamic load rating, radial
C_{0r}	2.220.000 N	Basic static load rating, radial
C_{ur}	222.000 N	Fatigue load limit, radial
n_G	2.070 1/min	Limiting speed
n_{gr}	1.260 1/min	Reference speed

Dimensions

r_{\min}	3 mm	Minimum chamfer dimension
D_1	281,6 mm	Bore diameter outer ring
d_s	8 mm	Diameter lubrication hole
n_s	15 mm	Width of lubricating groove

Mounting dimensions

$d_{a\min}$	204 mm	Minimum diameter shaft shoulder
$D_{a\max}$	306 mm	Maximum diameter of housing shoulder
$r_{a\max}$	2,5 mm	Maximum recess radius

Additional information

e	0,3	Limiting value of Fa/Fr for the applicability of diff. Values of factors X and Y
Y ₁	2,28	Dynamic axial load factor
Y ₂	3,39	Dynamic axial load factor
Y ₀	2,23	Static axial load factor