



FAG

★ 24036-BE-XL

Spherical roller bearing

Schaeffler ID:
0645370480000Spherical roller bearing 240..-BE-XL,
symmetric with rib washer

★ Preferred product

X-life

Technical information

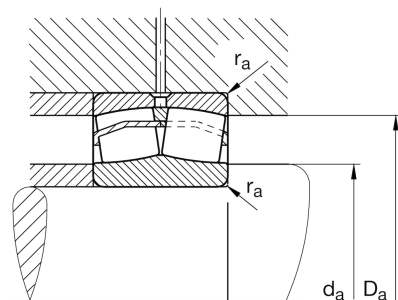
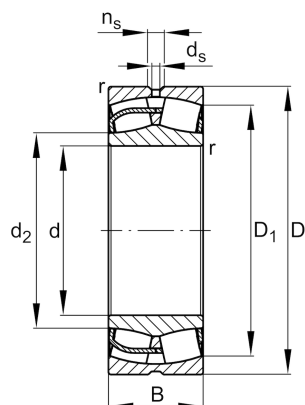

Temperature range

T_{\min}	-30 °C	Operating temperature min.
------------	--------	----------------------------

T_{\max}	200 °C	Operating temperature max.
------------	--------	----------------------------

	22,414 kg	Weight
--	-----------	--------

Main Dimensions & Performance Data

d	180 mm	Bore diameter
D	280 mm	Outside diameter
B	100 mm	Width
C_r	1.130.000 N	Basic dynamic load rating, radial
C_{0r}	1.770.000 N	Basic static load rating, radial
C_{ur}	185.000 N	Fatigue load limit, radial
n_G	2.200 1/min	Limiting speed
n_{gr}	1.420 1/min	Reference speed

Dimensions

r_{\min}	2,1 mm	Minimum chamfer dimension
D_1	244,6 mm	Bore diameter outer ring
d_2	201,7 mm	Raceway diameter of the inner ring
d_s	4,8 mm	Diameter lubrication hole
n_s	9,5 mm	Width of lubricating groove

Mounting dimensions

$d_{a\min}$	190,2 mm	Minimum diameter shaft shoulder
$D_{a\max}$	269,8 mm	Maximum diameter of housing shoulder
$r_{a\max}$	2,1 mm	Maximum recess radius

Additional information

e	0,32	Limiting value of Fa/Fr for the applicability of diff. Values of factors X and Y
Y ₁	2,1	Dynamic axial load factor
Y ₂	3,13	Dynamic axial load factor
Y ₀	2,06	Static axial load factor