

RNAO40X50X34-ZW-ASR1-XL

Needle roller bearing

Schaeffler ID:
0507760450000

Needle roller bearings RNAO...-ZW-ASR1,
without ribs, double row

X-life

Technical information

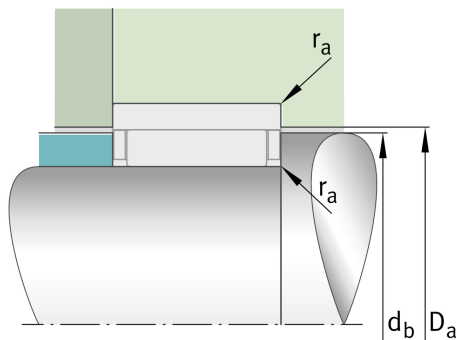
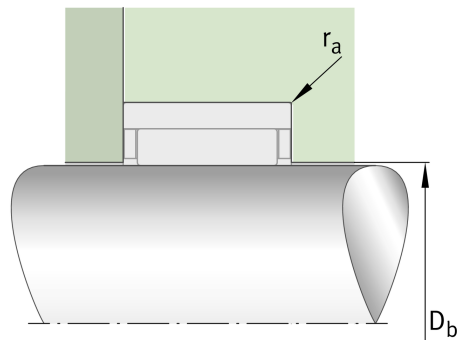
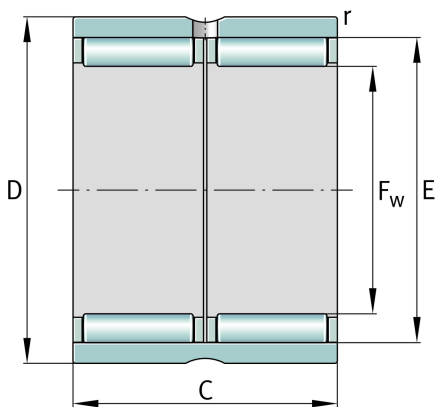

Main Dimensions & Performance Data

F_w	40 mm	Under roller diameter
D	50 mm	Outside diameter
C	34 mm	Width, outer ring
C_r	41.500 N	Basic dynamic load rating, radial
C_{0r}	83.000 N	Basic static load rating, radial
C_{ur}	13.100 N	Fatigue load limit, radial
n_G	11.500 1/min	Limiting speed
n_{gr}	7.000 1/min	Reference speed
	0,152 kg	Weight

Dimensions

E	45 mm	Raceway diameter outer ring
r_{min}	0,3 mm	Minimum chamfer dimension

Mounting dimensions

D_b	40,6 mm	Shoulder diameter axial guidance NK/housing
d_b	44,4 mm	Shoulder diameter axial guidance NK/shaft
D_a	45,5 mm	Shoulder diameter outer ring
$r_{a max}$	0,3 mm	Maximum recess radius

Temperature range

T_{min}	-30 °C	Operating temperature min.
T_{max}	120 °C	Operating temperature max.