

FAG

MS3176

Securing plate

Schaeffler ID:
0381229360000

Securing plate MS, locknut, DIN5406

Technical information

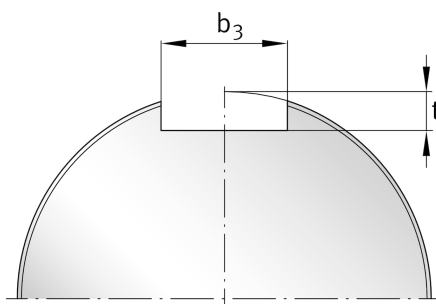
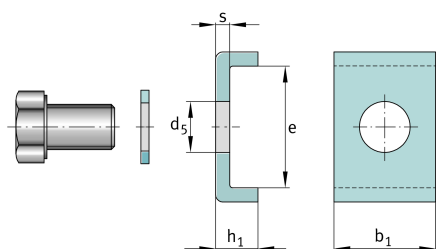
**Main Dimensions & Performance Data**

b_1	32 mm	Length retaining ring
e	40 mm	Width inner retaining ring
h_1	15 mm	Height retaining ring
	0,001 kg	Weight

Dimensions

s	5 mm	Thickness
	M12x22	Hexagonal bolt
	87 Nm	Mounting torque screw
d_5	14 mm	Diameter fixing hole spacing

Mounting dimensions

b_3	34 mm	Width retaining slot
t	10 mm	Height retaining slot