



## GE20-FW

### Spherical plain bearing

Schaeffler ID:  
0066499710000

Radial spherical plain bearing, maintenance-free, sliding layer: PTFE composite, inner ring curved surface with hard chromium coating, DIN ISO 12240-1, dimension series G, open design

#### Technical information

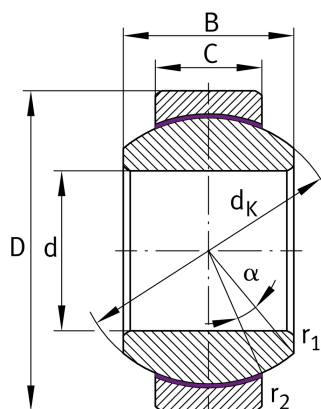
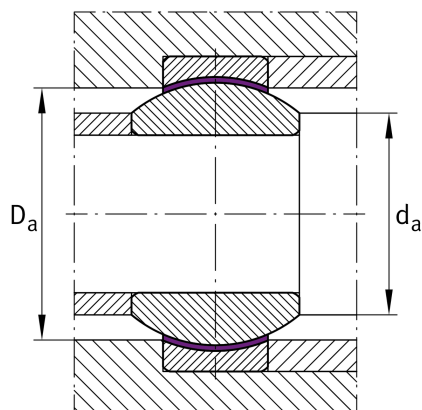

#### Main Dimensions & Performance Data

D	42 mm	Outside diameter bearing
d	20 mm	Bore diameter bearing
B	25 mm	Width Inner ring
C	16 mm	Width Outer ring
$C_r$	51.100 N	Basic dynamic load rating, radial
$C_{0r}$	128.000 N	Basic static load rating, radial
	0,156 kg	Weight

#### Dimensions

$d_K$	35,5 mm	Ball diameter
$\alpha$	17 °	Tilt angle
$G_r$	0 - 0,05 mm	Radial Clearance
$d_{OT}$	0 mm	Bore diameter bearing, upper tolerance
$d_{UT}$	-0,01 mm	Bore diameter bearing, lower tolerance
$D_{OT}$	0 mm	Outside diameter, upper tolerance
$D_{UT}$	-0,011 mm	Outside diameter, lower tolerance
$B_{OT}$	0 mm	Width inner ring, upper tolerance
$B_{UT}$	-0,12 mm	Width inner ring, lower tolerance
$C_{OT}$	0 mm	Width outer ring, upper tolerance
$C_{UT}$	-0,24 mm	Width outer ring, lower tolerance

#### Mounting dimensions

$r_{1smin}$	0,6 mm	Edge Spacing
$r_{2smin}$	0,6 mm	Edge Spacing
$d_{amax}$	25,2 mm	Connection measure Inner ring
$D_{amin}$	33 mm	Housing Connection Diameter

#### Temperature range

$T_{min}$	-50 °C	Operating temperature min.
$T_{max}$	200 °C	Operating temperature max.