



PCJTY17-XL

Flanged housing unit

Schaeffler ID:
0009543220000

Housing units PCJTY, two-bolt flanged housing units, cast iron, grub screws in inner ring, P seals

X-life

Technical information

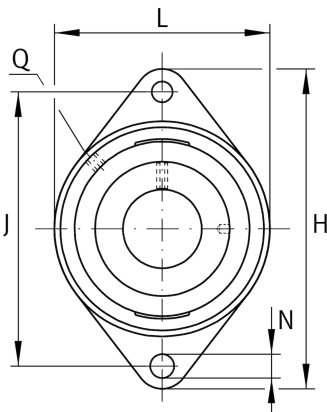

Main Dimensions & Performance Data

d	17 mm	Bore diameter
L	57 mm	Flange width
H	99 mm	Height flange
U	33 mm	Total height unit
C_r	10.100 N	Basic dynamic load rating, radial
C_{0r}	4.750 N	Basic static load rating, radial
C_{ur}	219 N	Fatigue load limit, radial
	0,34 kg	Weight

Dimensions

A	25 mm	Height housing
	1	Number of housings
A_1	9,5 mm	Thickness of flange
A_2	17 mm	Distance raceway
	CJT03	Housing
	GAY17-XL-NPP-B	Bearing designation
B	22 mm	Width
V	57 mm	Shoulder diameter housing
Q	M6	Connection thread lubrication

Mounting dimensions

J	76,5 mm	Distance fixing bore
N	11.5 mm	Fixing bore
n	2	Number of screwing holes

