



RA17-XL

Flanged housing unit

Schaeffler ID:
0008292690000

Flanged housing unit RA..-XL

X-life

Technical information

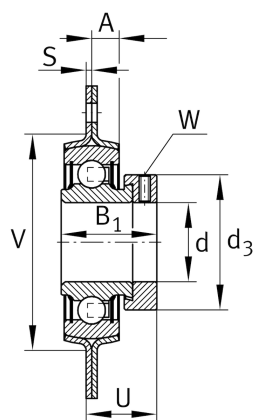
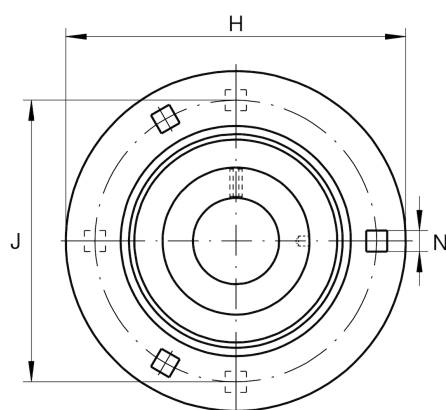

Main Dimensions & Performance Data

d	17 mm	Bore diameter
H	81 mm	Height flange
H	81 mm	Flange width
U	24 mm	Total height unit
B ₁	28,6 mm	Locking collar total width
C _{ur}	248 N	Fatigue load limit, radial
C _r	10.100 N	Basic dynamic load rating, radial
C _{0r}	4.750 N	Basic static load rating, radial
C _{0rG}	2.700 N	Load carrying capacity (housing)
	0,24 kg	Weight

Dimensions

A	7 mm	Height housing
	2	Number of housings
	FLAN40-MSB	Housing
	EXZ	Fixing
	RAE17-XL-NPP-B	Bearing designation
S	2 mm	Thickness of flange
V	48 mm	Shoulder diameter housing
d ₃	28,4 mm	Outside diameter locking collar/locknut

Mounting dimensions

J	63,5 mm	Pitch circle diameter (holes)
N	7,1 mm	Fixing square
n	3	Number of screwing holes