



RCJY16-XL

Flanged housing unit

Schaeffler ID:
0009708240000

Housing units RCJY, four-bolt flanged housing units, cast iron, grub screws in inner ring, R seals

X-life

Technical information

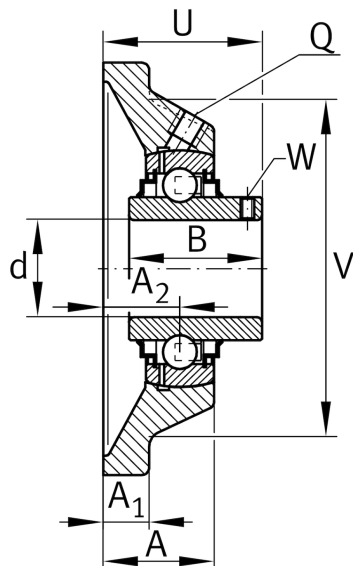
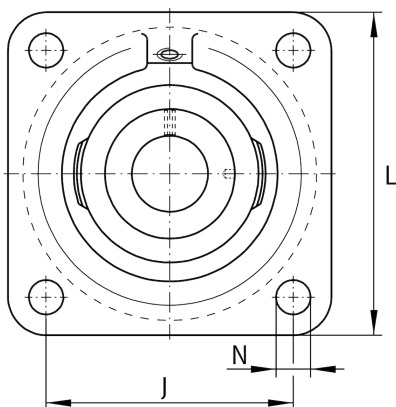

Main Dimensions & Performance Data

d	16 mm	Bore diameter
L	76 mm	Flange width
U	32,9 mm	Total height unit
C_r	10.100 N	Basic dynamic load rating, radial
C_{0r}	4.750 N	Basic static load rating, radial
C_{ur}	202 N	Fatigue load limit, radial
	0,44 kg	Weight

Dimensions

A	27 mm	Height housing
	1	Number of housings
A_1	9,5 mm	Thickness of flange
A_2	17 mm	Distance raceway
	CJ03	Housing
	GYE16-XL-KRR-B	Bearing designation
B	27,4 mm	Width
V	58 mm	Shoulder diameter housing
Q	M6	Connection thread lubrication

Mounting dimensions

J	54 mm	Distance fixing bore
N	11.5 mm	Fixing bore
n	4	Number of screwing holes