



## PHE20-XL

Take-up housing unit

Schaeffler ID:  
0008407930000

Take-up housing units PHE, cast iron housing, radial insert ball bearing with eccentric locking collar, P seals

X-life

### Technical information

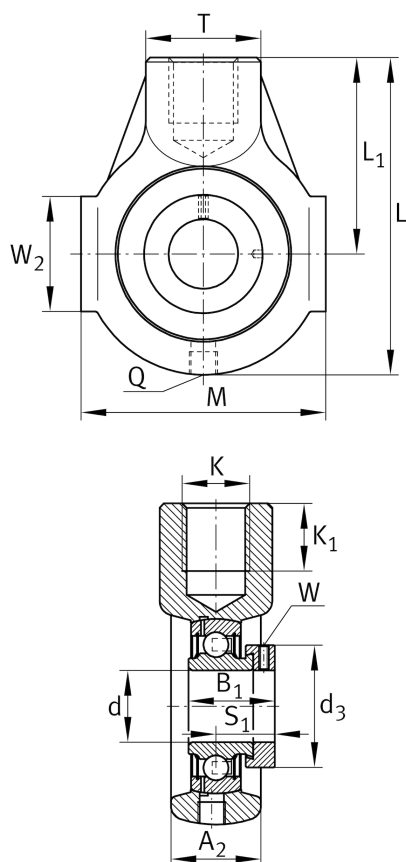

### Main Dimensions & Performance Data

d	20 mm	Bore diameter
L	91 mm	Length total
M	65 mm	Housing total width
A <sub>2</sub>	25 mm	Width housing
	0,55 kg	Weight

### Dimensions

L <sub>1</sub>	58 mm	Distance shaft axis
	HE04	Housing
	GRAE20-XL-NPP-B	Bearing designation
T	30 mm	Height housing fixing side
W	38 mm	Length of guidance face
Q	M6	Connection thread lubrication

### Mounting dimensions

K	M16	Thread fixing bore
K <sub>1</sub>	21 mm	Thread depth