



PHEY20-XL

Take-up housing unit

Schaeffler ID:
0009200450000

Take-up housing units PHEY, cast iron housing, radial insert ball bearing with grub screws in inner ring, P seals

X-life

Technical information

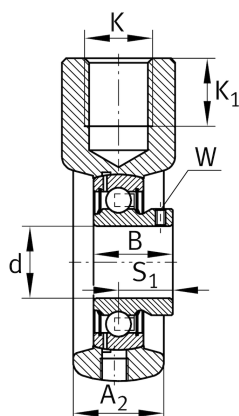
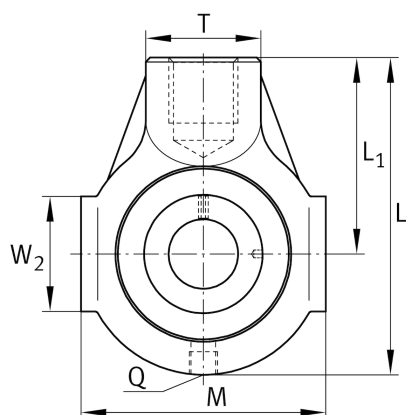

Main Dimensions & Performance Data

d	20 mm	Bore diameter
L	91 mm	Length total
M	65 mm	Housing total width
A ₂	25 mm	Width housing
	0,54 kg	Weight

Dimensions

L ₁	58 mm	Distance shaft axis
	HE04	Housing
	GAY20-XL-NPP-B	Bearing designation
T	30 mm	Height housing fixing side
W	38 mm	Length of guidance face
Q	M6	Connection thread lubrication

Mounting dimensions

K	M16	Thread fixing bore
K ₁	21 mm	Thread depth