



PHEY25-XL

Take-up housing unit

Schaeffler ID:
0009200610000

Take-up housing units PHEY, cast iron housing, radial insert ball bearing with grub screws in inner ring, P seals

X-life

Technical information

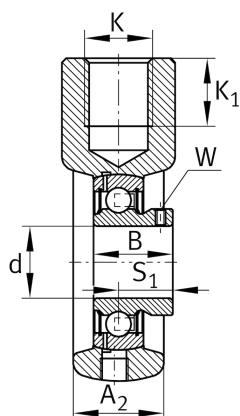
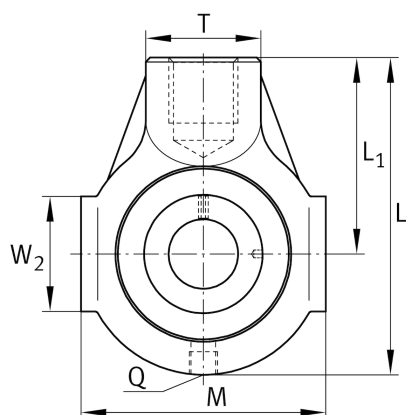

Main Dimensions & Performance Data

d	25 mm	Bore diameter
L	99 mm	Length total
M	70 mm	Housing total width
A ₂	28 mm	Width housing
	0,66 kg	Weight

Dimensions

L ₁	64 mm	Distance shaft axis
	HE05	Housing
	GAY25-XL-NPP-B	Bearing designation
T	35 mm	Height housing fixing side
W	38 mm	Length of guidance face
Q	M6	Connection thread lubrication

Mounting dimensions

K	M20	Thread fixing bore
K ₁	22 mm	Thread depth