

FAG

24136-BE-XL-K30

Spherical roller bearing

Schaeffler ID:
0650494700000Spherical roller bearings 241...-BE-K30,
main dimensions to DIN 635-2, with
tapered bore, taper 1:30

X-life

Technical information

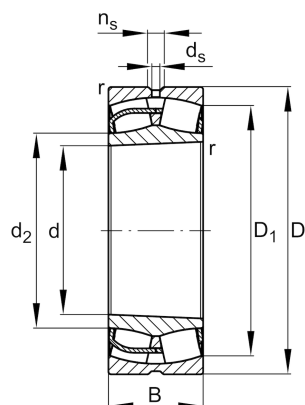

Main Dimensions & Performance Data

d	180 mm	Bore diameter
D	300 mm	Outside diameter
B	118 mm	Width
C_r	1.460.000 N	Basic dynamic load rating, radial
C_{0r}	2.170.000 N	Basic static load rating, radial
C_{ur}	208.000 N	Fatigue load limit, radial
n_G	2.000 1/min	Limiting speed
n_{gr}	980 1/min	Reference speed
	32,236 kg	Weight

Additional information

r_{min}	3 mm	Minimum chamfer dimension
D_1	255,7 mm	Bore diameter outer ring
	AH24136	Withdrawal sleeve
d_2	204,8 mm	Raceway diameter of the inner ring
d_s	6,3 mm	Diameter lubrication hole
n_s	12,2 mm	Width of lubricating groove

Mounting dimensions

$d_{a min}$	194 mm	Minimum diameter shaft shoulder
$D_{a max}$	286 mm	Maximum diameter of housing shoulder
$r_{a max}$	2,5 mm	Maximum recess radius

Calculation factors

e	0,36	Limiting value of F_a/F_r for the applicability of diff. Values of factors X and Y
Y_1	1,86	Dynamic axial load factor
Y_2	2,77	Dynamic axial load factor
Y_0	1,82	Static axial load factor

Temperature range

T _{min}	-30 °C	Operating temperature min.
T _{max}	200 °C	Operating temperature max.