

FAG

22334-BE-XL-JPA-T41A

Spherical roller bearing

Schaeffler ID:
0652083740000Spherical roller bearings 223...E1-T41A,
For oscillating load with restricted diameter
tolerances

X-life

Technical information

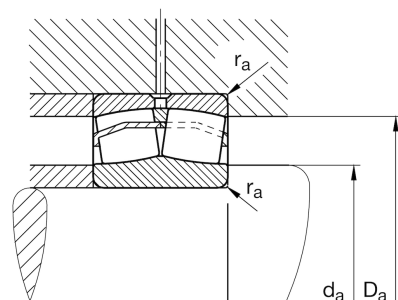
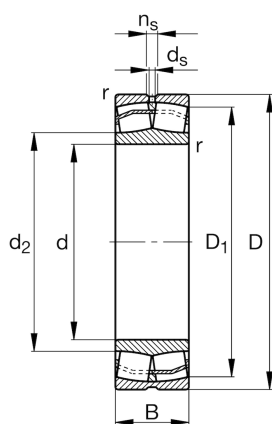

Main Dimensions & Performance Data

d	170 mm	Bore diameter
D	360 mm	Outside diameter
B	120 mm	Width
C_r	1.870.000 N	Basic dynamic load rating, radial
C_{0r}	2.220.000 N	Basic static load rating, radial
C_{ur}	178.000 N	Fatigue load limit, radial
n_G	2.130 1/min	Limiting speed
n_{gr}	1.320 1/min	Reference speed
	58,84 kg	Weight

Additional information

r_{min}	4 mm	Minimum chamfer dimension
D_1	303,9 mm	Bore diameter outer ring
d_2	213,1 mm	Raceway diameter of the inner ring
d_s	9,5 mm	Diameter lubrication hole
n_s	17,7 mm	Width of lubricating groove

Mounting dimensions

$d_{a min}$	187 mm	Minimum diameter shaft shoulder
$D_{a max}$	343 mm	Maximum diameter of housing shoulder
$r_{a max}$	3 mm	Maximum recess radius

Calculation factors

e	0,35	Limiting value of F_a/F_r for the applicability of diff. Values of factors X and Y
Y_1	1,95	Dynamic axial load factor
Y_2	2,9	Dynamic axial load factor
Y_0	1,91	Static axial load factor

Temperature range

T _{min}	-30 °C	Operating temperature min.
T _{max}	200 °C	Operating temperature max.