

FAG

22340-BE-XL-JPA-T41A

Spherical roller bearing

Schaeffler ID:
0645971300000Spherical roller bearings 223...E1-T41A,
For oscillating load with restricted diameter
tolerances

X-life

Technical information

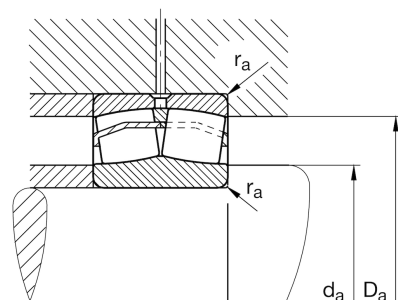
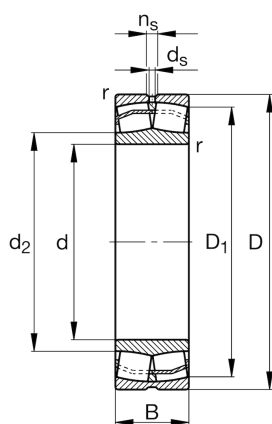

Main Dimensions & Performance Data

d	200 mm	Bore diameter
D	420 mm	Outside diameter
B	138 mm	Width
C_r	2.440.000 N	Basic dynamic load rating, radial
C_{0r}	2.950.000 N	Basic static load rating, radial
C_{ur}	232.000 N	Fatigue load limit, radial
n_G	1.830 1/min	Limiting speed
n_{gr}	1.080 1/min	Reference speed
	91,485 kg	Weight

Additional information

r_{min}	5 mm	Minimum chamfer dimension
D_1	355,1 mm	Bore diameter outer ring
d_2	248,8 mm	Raceway diameter of the inner ring
d_s	12,5 mm	Diameter lubrication hole
n_s	23,5 mm	Width of lubricating groove

Mounting dimensions

$d_{a min}$	220 mm	Minimum diameter shaft shoulder
$D_{a max}$	400 mm	Maximum diameter of housing shoulder
$r_{a max}$	4 mm	Maximum recess radius

Calculation factors

e	0,34	Limiting value of F_a/F_r for the applicability of diff. Values of factors X and Y
Y_1	1,98	Dynamic axial load factor
Y_2	2,94	Dynamic axial load factor
Y_0	1,93	Static axial load factor

Temperature range

T _{min}	-30 °C	Operating temperature min.
T _{max}	200 °C	Operating temperature max.