



FAG

SNS3244-H-D

Plummer block housing

Schaeffler ID:
0806338890000

Plummer block housing, split, for spherical roller bearings, metric and inch size shaft diameters, for grease lubrication

Technical information

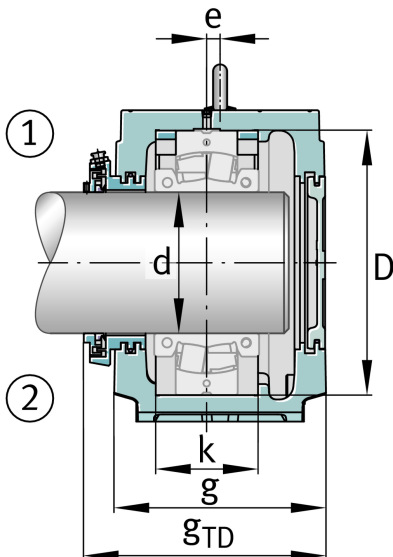
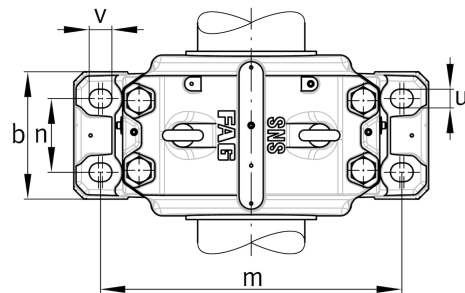
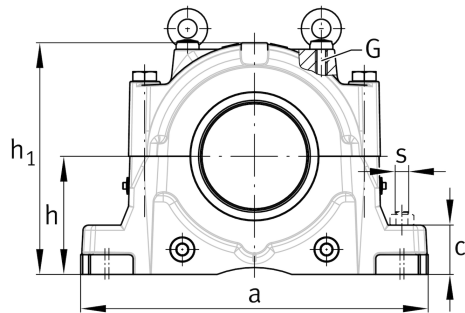
**Main Dimensions & Performance Data**

h_1	474 mm	Housing height
g	310 mm	Housing width
a	700 mm	length base
	183,4 kg	Weight

Dimensions

c	95 mm	Base height
b	260 mm	Base width
n_2	150 mm	Base hole distance 2
D	400 mm	Bearing seat
e	12 mm	Center offset
h	240 mm	Center height
k	164 mm	Bearing seat width
m	600 mm	Base hole distance 1
s	M30	Screw size base hole fixing
u	35 mm	Base hole width
v	42 mm	Base hole length

