



FAG

**SNS3048-Z-D**

Plummer block housing

Schaeffler ID:  
0806102000000

Plummer block housing, split, for spherical roller bearings with cylindrical bore, metric shaft diameters, for grease lubrication

## Technical information

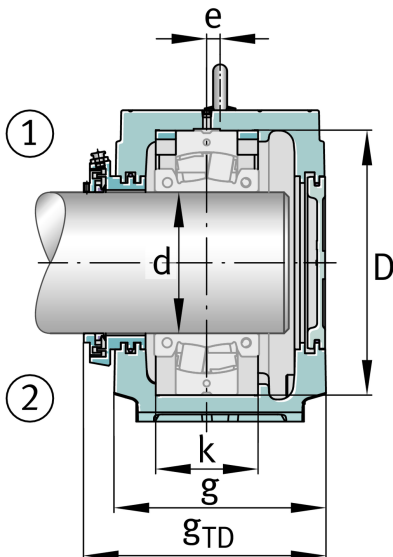
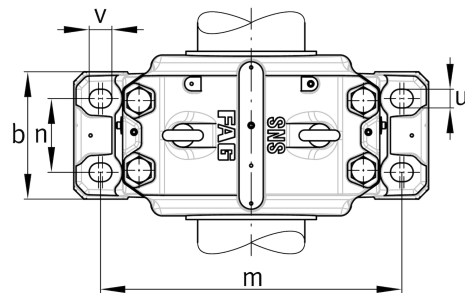
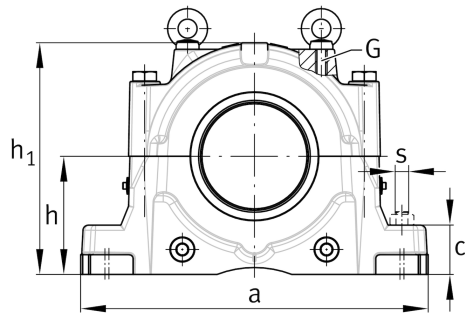
**Main Dimensions & Performance Data**

$h_1$	434 mm	Housing height
$g$	290 mm	Housing width
$a$	640 mm	length base
	139,3 kg	Weight

**Dimensions**

$c$	90 mm	Base height
$b$	240 mm	Base width
$n_2$	140 mm	Base hole distance 2
$D$	360 mm	Bearing seat
$e$	12 mm	Center offset
$h$	220 mm	Center height
$k$	140 mm	Bearing seat width
$m$	540 mm	Base hole distance 1
$s$	M30	Screw size base hole fixing
$u$	35 mm	Base hole width
$v$	42 mm	Base hole length

