



FAG

**SNS3136-Z-D**

Plummer block housing

Schaeffler ID:  
0806124310000

Plummer block housing, split, for spherical roller bearings with cylindrical bore, metric shaft diameters, for grease lubrication

## Technical information

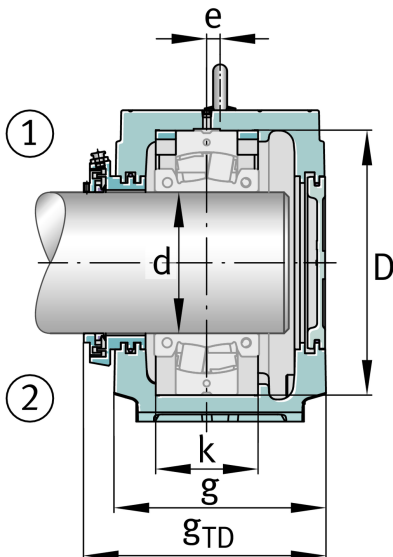
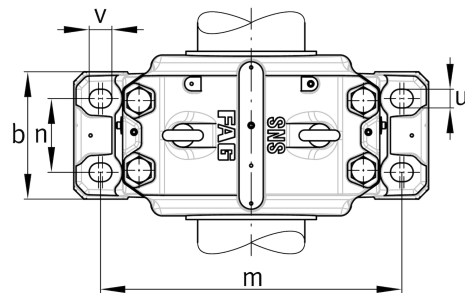
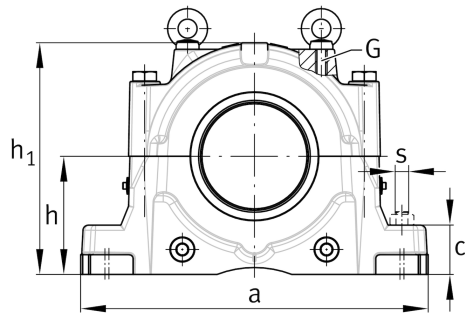
**Main Dimensions & Performance Data**

$h_1$	353 mm	Housing height
$g$	240 mm	Housing width
$a$	530 mm	length base
	76,3 kg	Weight

**Dimensions**

$c$	75 mm	Base height
$b$	190 mm	Base width
$n_2$	110 mm	Base hole distance 2
$D$	300 mm	Bearing seat
$e$	15 mm	Center offset
$h$	180 mm	Center height
$k$	116 mm	Bearing seat width
$m$	450 mm	Base hole distance 1
$s$	M24	Screw size base hole fixing
$u$	28 mm	Base hole width
$v$	34 mm	Base hole length

