



FAG

SNS3236-Z-D

Plummer block housing

Schaeffler ID:
0806336680000

Plummer block housing, split, for spherical roller bearings with cylindrical bore, metric shaft diameters, for grease lubrication

Technical information

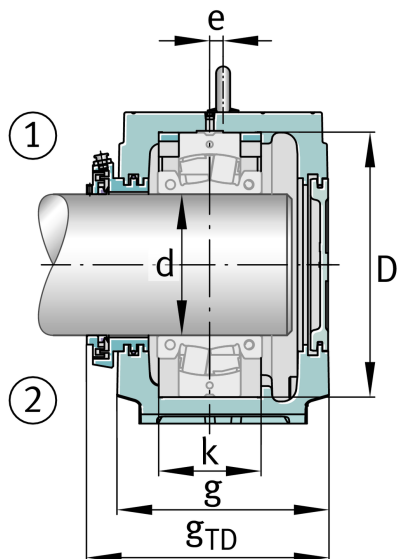
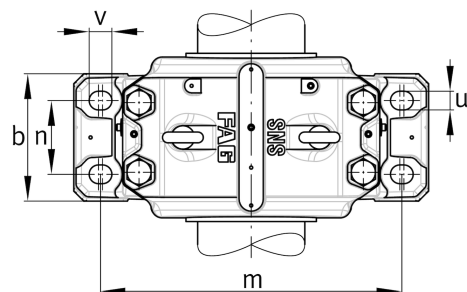
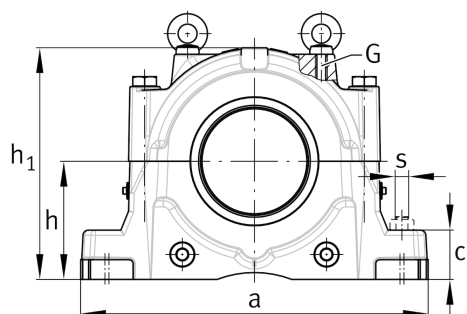
**Main Dimensions & Performance Data**

h_1	375 mm	Housing height
g	260 mm	Housing width
a	560 mm	length base
	96,4 kg	Weight

Dimensions

c	80 mm	Base height
b	210 mm	Base width
n_2	120 mm	Base hole distance 2
D	320 mm	Bearing seat
e	10 mm	Center offset
h	190 mm	Center height
k	124 mm	Bearing seat width
m	480 mm	Base hole distance 1
s	M24	Screw size base hole fixing
u	28 mm	Base hole width
v	34 mm	Base hole length

