

## KBO40-PP-AS

Linear ball bearing

Schaeffler ID:  
0015242590000

Linear ball bearings KBO..-PP-AS, machined range, open design, sealed on all sides, with relubrication facility, corrosion-resistant design possible

### Technical information

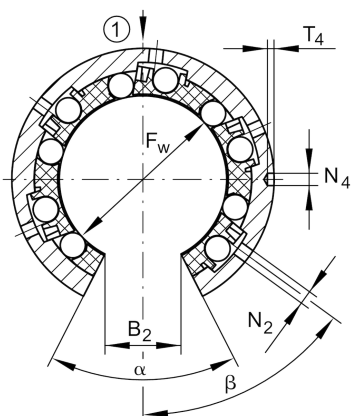
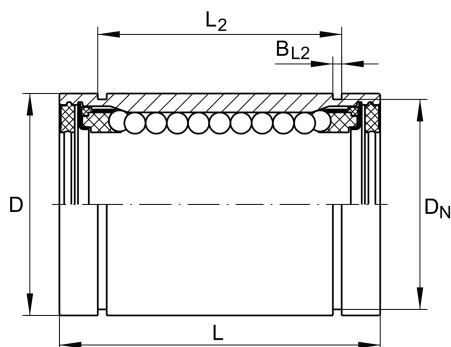

### Main Dimensions & Performance Data

$F_w$	40 mm	Bore diameter of ball complement
$D$	62 mm	Outside diameter
$L$	80 mm	length
	h12	Tolerance
$C_{max}$	6.100 N	load capacity dyn.
$C_{0max}$	4.600 N	load capacity stat.
	0,005 kg	Weight

### Mounting dimensions

$B_2$	18,2 mm	Width of sector opening
$L_2$	60,3 mm	
	H13	Tolerance
$B_{L2}$	2,15 mm	
$D_N$	59 mm	
$T_4$	1,5 mm	
$N_4$	3 mm	
$N_2$	3 mm	
$\alpha$	54 °	Angle of sector opening
$\beta$	54 °	
	5	Number of rows balls