

KBO50-PP

Linear ball bearing

Schaeffler ID:
0012758790000

Linear ball bearings KBO..-PP, machined range, open design, sealed on all sides, corrosion-resistant design possible

Technical information

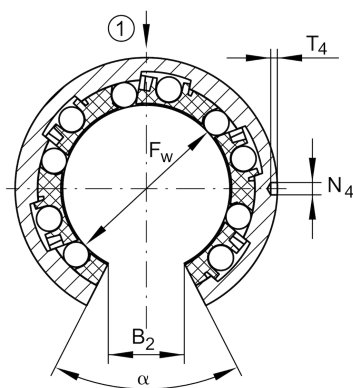
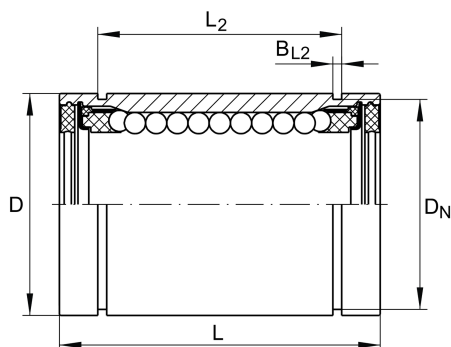

Main Dimensions & Performance Data

F_w	50 mm	Bore diameter of ball complement
D	75 mm	Outside diameter
L	100 mm	length
	h12	Tolerance
C_{max}	8.900 N	load capacity dyn.
C_{0max}	6.600 N	load capacity stat.
	0,838 kg	Weight

Mounting dimensions

B_2	22,7 mm	Width of sector opening
L_2	77,3 mm	
	H13	Tolerance
B_{L2}	2,65 mm	
D_N	72 mm	
T_4	1,5 mm	
N_4	3 mm	
N_2	4 mm	
α	54 °	Angle of sector opening
β	54 °	
	5	Number of rows balls