



RUSV42086-KS

Linear recirculating roller bearing unit

Schaeffler ID:
0010039410000

Linear roller bearings, with spacer
elements, with integrated adjusting gib,
RUSV...-KS

Technical information

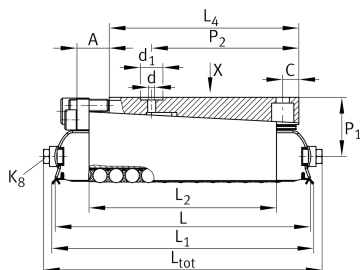

Main Dimensions & Performance Data

L	98 mm	Length total
B	40 mm	Width
H	42 mm	Height
C	76.000 N	Basic dynamic load capacity
C ₀	113.000 N	Basic static load capacity
	0,84 kg	Weight

Mounting dimensions

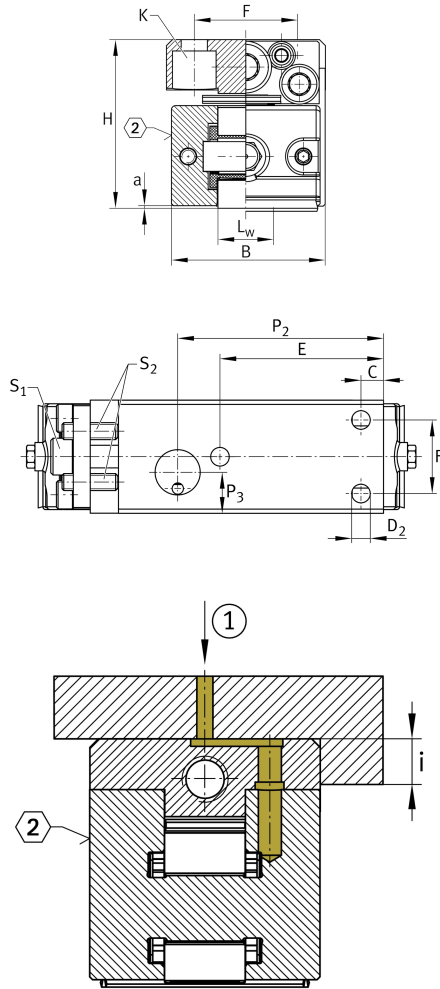

UG9741, UGN9741-A, suitable Guide Rails
 UZ9741, UZN9741-A,
 UFK4710, UFB6412

L	86 mm	
L ₁	92 mm	
L ₃	52,4 mm	
L ₄	54 mm	
a	0,3 mm	
L _w	14 mm	
C	8 mm	
E	23 mm	Mounting dimension
F	26 mm	
i	6 mm	Mounting dimension
P ₁	29,5 mm	
d ₁	16 mm	
P ₂	38 mm	
P ₃	14,5 mm	
d	3 mm	
K	M6	Lubrication connector DIN3405-A
S ₁	6 mm	Hexagon socket adjusting screw
S ₂	3 mm	Hexagon socket counter forcing screw
K	M6	Size thread k DIN
K M _A	17 Nm	Tightening torque fixing screws
D ₂	6,6 mm	
A _{max}	10 mm	Screw stroke A
Delta h _{max}	0,52 mm	Adjustment maximum
	0,05 mm	Adjustment screw revolution