

RUSV60134-KS

Linear recirculating roller bearing unit

Schaeffler ID:
0010039760000

Linear roller bearings, with spacer elements, with integrated adjusting gib, RUSV...-KS

Technical information

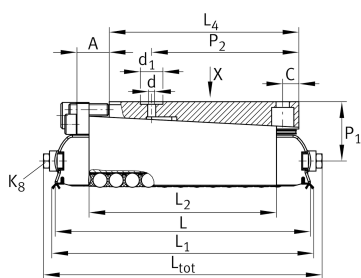

Main Dimensions & Performance Data

L	143 mm	Length total
B	52 mm	Width
H	60 mm	Height
C	179.000 N	Basic dynamic load capacity
C ₀	275.000 N	Basic static load capacity
	2,48 kg	Weight

Mounting dimensions

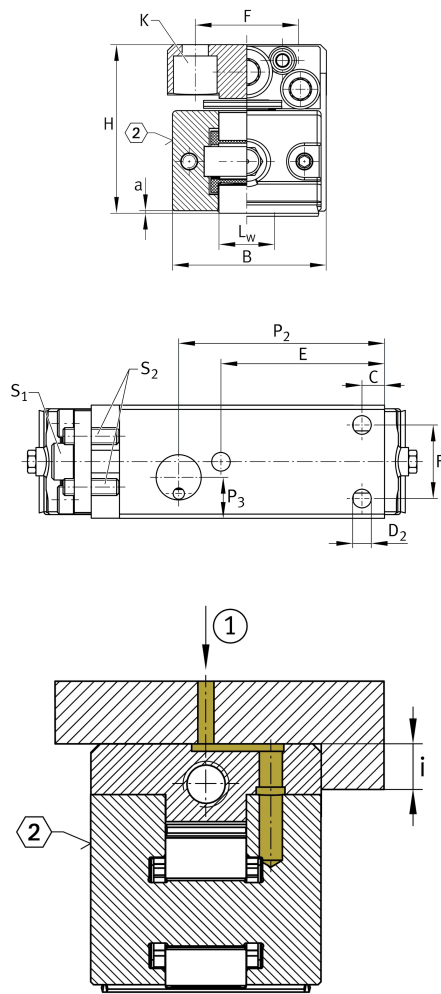

UG12553, UGN12553- suitable Guide Rails

A, UZ12553,

UZN12553-A,

UFK6412, UFB7812

L	134 mm	
L ₁	133 mm	
L ₃	85 mm	
L ₄	86 mm	
a	0,3 mm	
L _w	20 mm	
C	10 mm	
E	45 mm	Mounting dimension
F	35 mm	
i	8 mm	Mounting dimension
P ₁	41,5 mm	
d ₁	22 mm	
P ₂	65 mm	
P ₃	18 mm	
d	4 mm	
K	M6	Lubrication connector DIN3405-A
S ₁	8 mm	Hexagon socket adjusting screw
S ₂	4 mm	Hexagon socket counter forcing screw
K	M6	Size thread k DIN
K M _A	41 Nm	Tightening torque fixing screws
D ₂	8,6 mm	
A _{max}	15 mm	Screw stroke A
Delta h _{max}	0,78 mm	Adjustment maximum
	0,062 mm	Adjustment screw revolution