



RUSV30069-KS

Linear recirculating roller bearing unit

Schaeffler ID:
0007200200000

Linear roller bearings, with spacer
elements, with integrated adjusting gib,
RUSV...-KS

Technical information

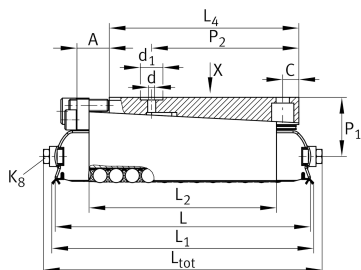

Main Dimensions & Performance Data

L	82 mm	Length total
B	27 mm	Width
H	30 mm	Height
C	42.000 N	Basic dynamic load capacity
C ₀	66.000 N	Basic static load capacity
	0,003 kg	Weight

Mounting dimensions

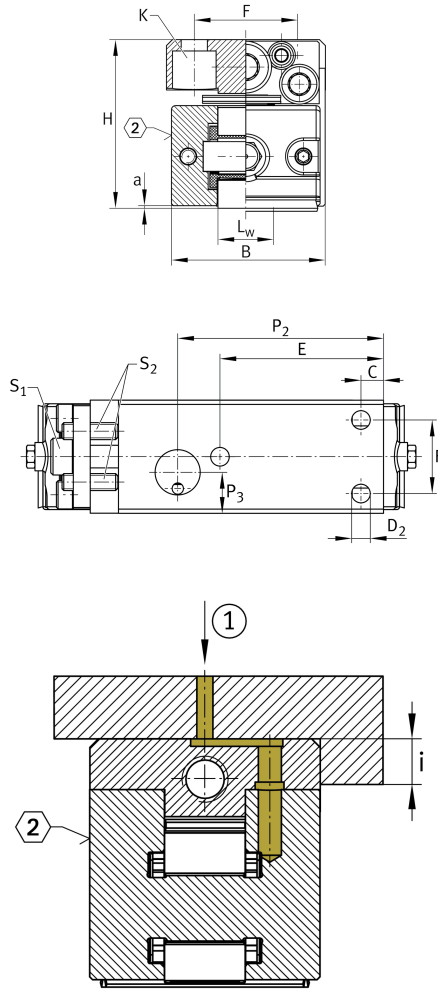

	UG6628, UGN6628, UZ6628, UZN6628, U FK3210, UFB4710	suitable Guide Rails
L	69 mm	
L ₁	75 mm	
L ₃	43,5 mm	
L ₄	45 mm	
a	0,3 mm	
L _w	10 mm	
C	5 mm	
E	25 mm	Mounting dimension
F	19 mm	
i	4 mm	Mounting dimension
P ₁	21 mm	
d ₁	12 mm	
P ₂	33 mm	
P ₃	9 mm	
d	2,5 mm	
K	M6	Lubrication connector DIN3405-A
S ₁	3 mm	Hexagon socket adjusting screw
S ₂	2 mm	Hexagon socket counter forcing screw
K	M4	Size thread k DIN
K M _A	5 Nm	Tightening torque fixing screws
D ₂	4,5 mm	
A _{max}	7 mm	Screw stroke A
Delta h _{max}	0,37 mm	Adjustment maximum
	0,035 mm	Adjustment screw revolution