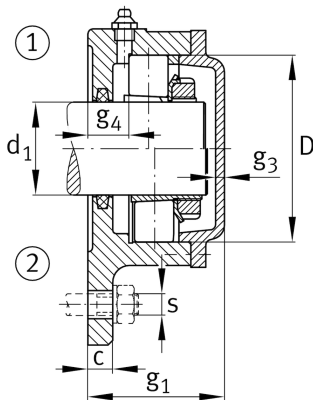
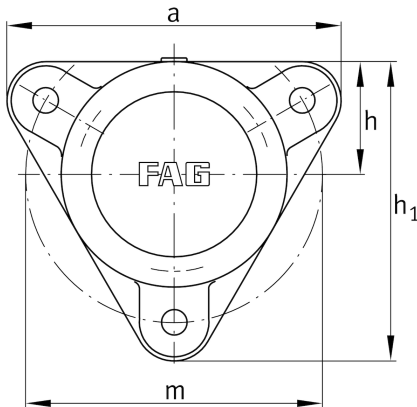

**FAG****F506-A-L**

Flanged housing

Schaeffler ID:
0191671990000Flanged housing for various bearing types,
with conical bore and clamping sleeve,
closed on one side

Technical information

**Main Dimensions & Performance Data**

d_1	25 mm	Shaft diameter
a	130 mm	Flange width
h_1	117 mm	height flange
g_2	55 mm	total width with cover
	3	number of fastening holes
	1,6 kg	Weight

Dimensions

	M10x1	connection thread lubrication
c	12 mm	thickness of flange
D	62 mm	outside diameter bearing
g_4	18 mm	distance flange to bearing seat
h	44 mm	distance shaft axis
m	116 mm	pitch circle diameter fixing holes
s	M10	size of fixing screws