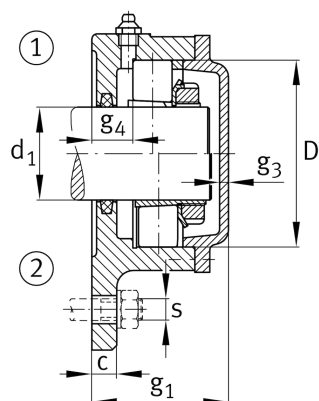
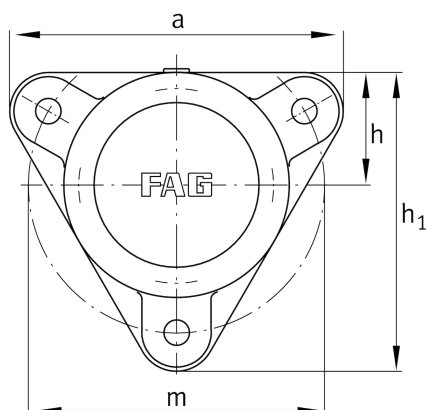

**FAG****F510-A-L**

Flanged housing

Schaeffler ID:
0382810580000Flanged housing for various bearing types,
with conical bore and clamping sleeve,
closed on one side

Technical information

**Main Dimensions & Performance Data**

d_1	45 mm	Shaft diameter
a	180 mm	Flange width
h_1	160 mm	height flange
g_2	65 mm	total width with cover
	3	number of fastening holes
	3,3 kg	Weight

Dimensions

	M10x1	connection thread lubrication
c	15 mm	thickness of flange
D	90 mm	outside diameter bearing
g_4	20 mm	distance flange to bearing seat
h	60 mm	distance shaft axis
m	160 mm	pitch circle diameter fixing holes
s	M12	size of fixing screws