

**FAG**★ **F512-WB-L**

Flanged housing

Schaeffler ID:
0383830200000

★ Preferred product

Flanged housing for various bearing types, wide version with conical bore and clamping sleeve, continuous shaft

Technical information

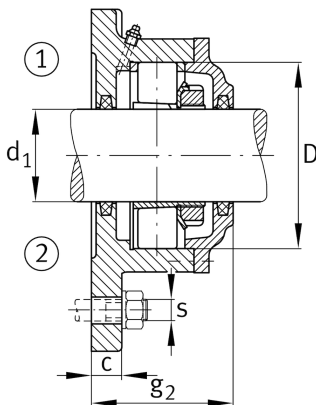
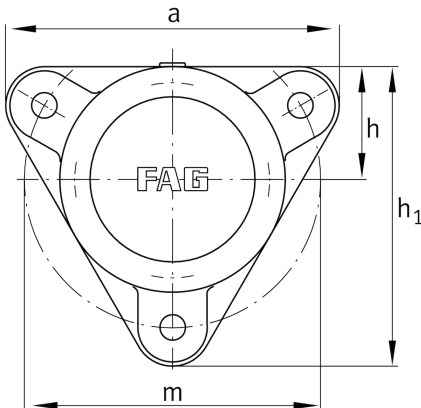
**Main Dimensions & Performance Data**

d_1	55 mm	Shaft diameter
a	206 mm	Flange width
h_1	185 mm	height flange
g_2	84 mm	total width with cover
	3	number of fastening holes
	4,8 kg	Weight

Dimensions

	M10x1	connection thread lubrication
c	16 mm	thickness of flange
D	110 mm	outside diameter bearing
g_4	24 mm	distance flange to bearing seat
h	70 mm	distance shaft axis
m	180 mm	pitch circle diameter fixing holes
s	M12	size of fixing screws