

**FAG**★ **F513-A-L**

Flanged housing

Schaeffler ID:
0191673260000Flanged housing for various bearing types,
with conical bore and clamping sleeve,
closed on one side

★ Preferred product

Technical information

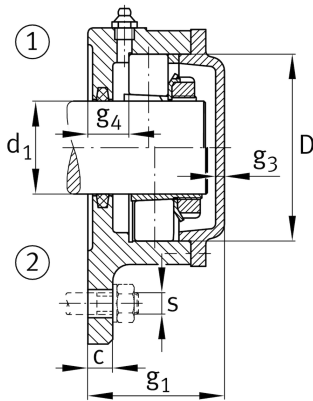
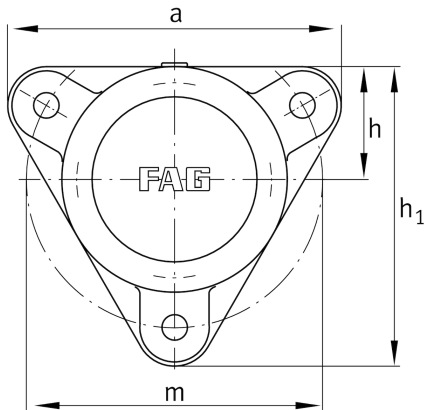
**Main Dimensions & Performance Data**

d_1	60 mm	Shaft diameter
a	219 mm	Flange width
h_1	198 mm	height flange
g_2	75 mm	total width with cover
	3	number of fastening holes
	5,225 kg	Weight

Dimensions

	M10x1	connection thread lubrication
c	16 mm	thickness of flange
D	120 mm	outside diameter bearing
g_4	24 mm	distance flange to bearing seat
h	75 mm	distance shaft axis
m	190 mm	pitch circle diameter fixing holes
s	M12	size of fixing screws