



FAG

★ 22214-E1-XL

Spherical roller bearing

Schaeffler ID:
0167038390000Spherical roller bearings 222...-E1, main
dimensions to DIN 635-2

★ Preferred product

X-life

Technical information

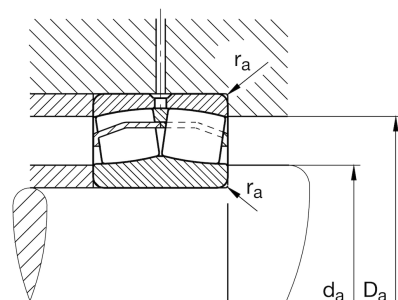
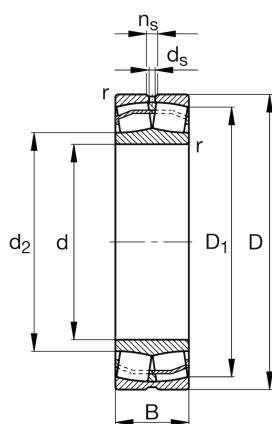

Temperature range

T_{\min}	-30 °C	Operating temperature min.
T_{\max}	200 °C	Operating temperature max.
	1,6 kg	Weight

Main Dimensions & Performance Data

d	70 mm	Bore diameter
D	125 mm	Outside diameter
B	31 mm	Width
C_r	211.000 N	Basic dynamic load rating, radial
C_{0r}	226.000 N	Basic static load rating, radial
C_{ur}	28.500 N	Fatigue load limit, radial
n_G	6.700 1/min	Limiting speed
n_{gr}	3.950 1/min	Reference speed

Dimensions

r_{\min}	1,5 mm	Minimum chamfer dimension
D_1	112,5 mm	Bore diameter outer ring
d_2	84,4 mm	Raceway diameter of the inner ring
d_s	3,2 mm	Diameter lubrication hole
n_s	6,5 mm	Width of lubricating groove

Mounting dimensions

$d_{a\min}$	79 mm	Minimum diameter shaft shoulder
$D_{a\max}$	116 mm	Maximum diameter of housing shoulder
$r_{a\max}$	1,5 mm	Maximum recess radius

Additional information

e	0,23	Limiting value of Fa/Fr for the applicability of diff. Values of factors X and Y
Y ₁	2,95	Dynamic axial load factor
Y ₂	4,4	Dynamic axial load factor
Y ₀	2,89	Static axial load factor