

FAG

★ 22316-E1-XL

Spherical roller bearing

Schaeffler ID:
0167055990000Spherical roller bearings 223...-E1, main
dimensions to DIN 635-2

★ Preferred product

X-life

Technical information

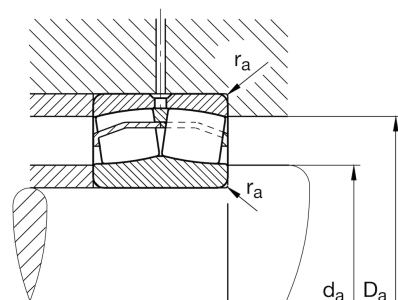
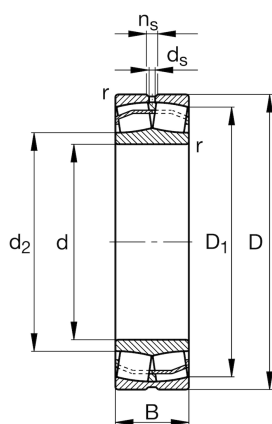

Temperature range

T_{\min}	-30 °C	Operating temperature min.
T_{\max}	200 °C	Operating temperature max.
	6,265 kg	Weight

Main Dimensions & Performance Data

d	80 mm	Bore diameter
D	170 mm	Outside diameter
B	58 mm	Width
C_r	495.000 N	Basic dynamic load rating, radial
C_{0r}	510.000 N	Basic static load rating, radial
C_{ur}	46.500 N	Fatigue load limit, radial
n_G	4.250 1/min	Limiting speed
n_{gr}	3.400 1/min	Reference speed

Dimensions

r_{\min}	2,1 mm	Minimum chamfer dimension
D_1	145,1 mm	Bore diameter outer ring
d_2	98,3 mm	Raceway diameter of the inner ring
d_s	4,8 mm	Diameter lubrication hole
n_s	9,5 mm	Width of lubricating groove

Mounting dimensions

$d_{a\min}$	92 mm	Minimum diameter shaft shoulder
$D_{a\max}$	158 mm	Maximum diameter of housing shoulder
$r_{a\max}$	2,1 mm	Maximum recess radius

Additional information

e	0,34	Limiting value of Fa/Fr for the applicability of diff. Values of factors X and Y
Y ₁	1,99	Dynamic axial load factor
Y ₂	2,96	Dynamic axial load factor
Y ₀	1,94	Static axial load factor