

FAG

★ 22219-E1-XL

Spherical roller bearing

Schaeffler ID:
0190004300000Spherical roller bearings 222...-E1, main
dimensions to DIN 635-2

★ Preferred product

X-life

Technical information

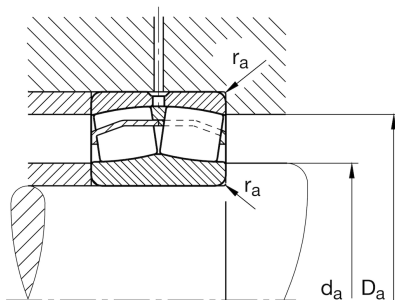
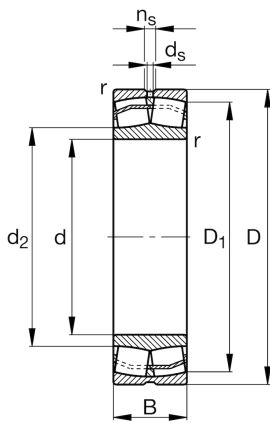

Temperature range

T_{\min}	-30 °C	Operating temperature min.
T_{\max}	200 °C	Operating temperature max.
	4,044 kg	Weight

Main Dimensions & Performance Data

d	95 mm	Bore diameter
D	170 mm	Outside diameter
B	43 mm	Width
C_r	380.000 N	Basic dynamic load rating, radial
C_{0r}	415.000 N	Basic static load rating, radial
C_{ur}	48.500 N	Fatigue load limit, radial
n_G	4.850 1/min	Limiting speed
n_{gr}	3.300 1/min	Reference speed

Dimensions

r_{\min}	2,1 mm	Minimum chamfer dimension
D_1	152,7 mm	Bore diameter outer ring
d_2	112,6 mm	Raceway diameter of the inner ring
d_s	4,8 mm	Diameter lubrication hole
n_s	9,5 mm	Width of lubricating groove

Mounting dimensions

$d_{a\min}$	107 mm	Minimum diameter shaft shoulder
$D_{a\max}$	158 mm	Maximum diameter of housing shoulder
$r_{a\max}$	2,1 mm	Maximum recess radius

Additional information

e	0,24	Limiting value of Fa/Fr for the applicability of diff. Values of factors X and Y
Y ₁	2,87	Dynamic axial load factor
Y ₂	4,27	Dynamic axial load factor
Y ₀	2,8	Static axial load factor