

FAG

★ 23022-E1A-XL-M

Spherical roller bearing

Schaeffler ID:
0190246140000Spherical roller bearings 230...-E1A, main
dimensions to DIN 635-2

★ Preferred product

X-life

Technical information

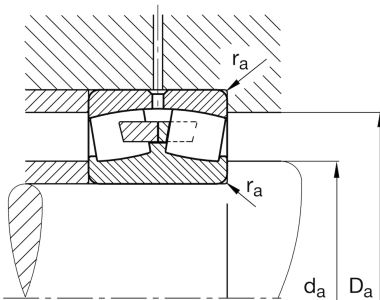
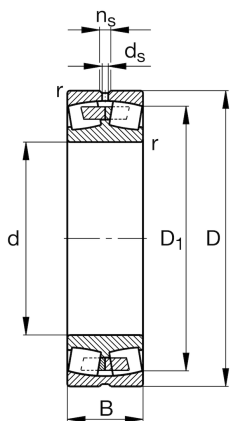

Temperature range

T_{\min}	-30 °C	Operating temperature min.
T_{\max}	200 °C	Operating temperature max.
	3,679 kg	Weight

Main Dimensions & Performance Data

d	110 mm	Bore diameter
D	170 mm	Outside diameter
B	45 mm	Width
C_r	400.000 N	Basic dynamic load rating, radial
C_{0r}	530.000 N	Basic static load rating, radial
C_{ur}	54.000 N	Fatigue load limit, radial
n_G	4.200 1/min	Limiting speed
n_{gr}	3.000 1/min	Reference speed

Dimensions

r_{\min}	2 mm	Minimum chamfer dimension
D_1	154,6 mm	Bore diameter outer ring
d_s	3,2 mm	Diameter lubrication hole
n_s	6,5 mm	Width of lubricating groove

Mounting dimensions

$d_{a\min}$	118,8 mm	Minimum diameter shaft shoulder
$D_{a\max}$	161,2 mm	Maximum diameter of housing shoulder
$r_{a\max}$	2 mm	Maximum recess radius

Additional information

e	0,23	Limiting value of Fa/Fr for the applicability of diff. Values of factors X and Y
Y ₁	2,9	Dynamic axial load factor
Y ₂	4,31	Dynamic axial load factor
Y ₀	2,83	Static axial load factor