

FAG

★ 6004-C-2HRS

Deep groove ball bearing

Schaeffler ID:
0618372960000Deep groove ball bearing 60...-C-2HRS,
single row, Generation C, seals, steel
sheet metal cage

★ Preferred product

Technical information

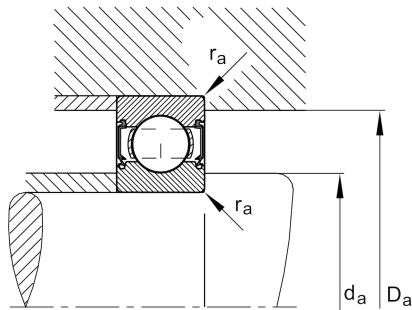
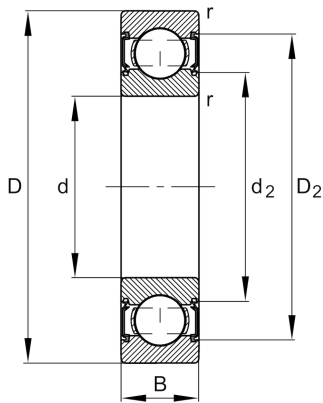

Temperature range

T_{\min}	-20 °C	Operating temperature min.
T_{\max}	110 °C	Operating temperature max.
	0,065 kg	Weight

Main Dimensions & Performance Data

d	20 mm	Bore diameter
D	42 mm	Outside diameter
B	12 mm	Width
C_r	10.600 N	Basic dynamic load rating, radial
C_{0r}	5.000 N	Basic static load rating, radial
C_{ur}	340 N	Fatigue load limit, radial
n_G	15.300 1/min	Limiting speed

Dimensions

r_{\min}	0,6 mm	Minimum chamfer dimension
D_2	37,4 mm	Caliber diameter outer ring
d_2	25,2 mm	Caliber diameter inner ring

Mounting dimensions

$d_{a\min}$	23,2 mm	Minimum diameter shaft shoulder
$D_{a\max}$	38,8 mm	Maximum diameter of housing shoulder
$r_{a\max}$	0,6 mm	Maximum fillet radius

Calculation factors

f_0	13,8	Calculation factor
-------	------	--------------------