

FAG

★ 6200-C-2HRS

Deep groove ball bearing

Schaeffler ID:
0621487960000Deep groove ball bearing 62...-C-2HRS,
single row, Generation C, seals, steel
sheet metal cage

★ Preferred product

Technical information

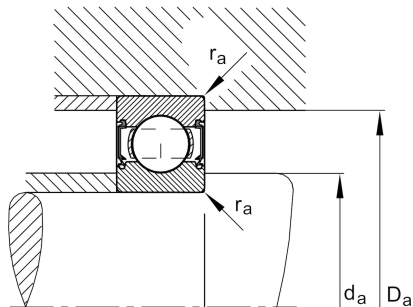
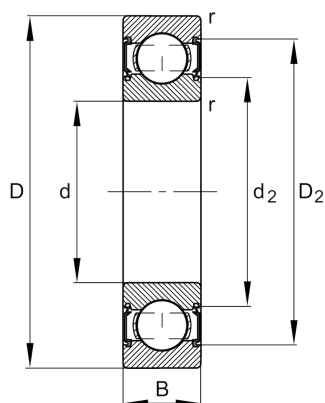

Temperature range

T_{\min}	-20 °C	Operating temperature min.
T_{\max}	110 °C	Operating temperature max.
	0,03 kg	Weight

Main Dimensions & Performance Data

d	10 mm	Bore diameter
D	30 mm	Outside diameter
B	9 mm	Width
C_r	7.000 N	Basic dynamic load rating, radial
C_{0r}	2.600 N	Basic static load rating, radial
C_{ur}	181 N	Fatigue load limit, radial
n_G	26.000 1/min	Limiting speed

Dimensions

r_{\min}	0,6 mm	Minimum chamfer dimension
D_2	25,7 mm	Caliber diameter outer ring
d_2	15,1 mm	Caliber diameter inner ring

Mounting dimensions

$d_{a\min}$	14,2 mm	Minimum diameter shaft shoulder
$D_{a\max}$	25,8 mm	Maximum diameter of housing shoulder
$r_{a\max}$	0,6 mm	Maximum fillet radius

Calculation factors

f_0	12	Calculation factor
-------	----	--------------------