

FAG

## ★ 3210-BD-XL-2HRS-TVH

Angular contact ball bearing

Schaeffler ID:  
0624089170000Angular contact ball bearing 32..-BD-  
XL-2HRS-TVH, double row, X-life, seals,  
plastic cage

★ Preferred product

X-life

## Technical information

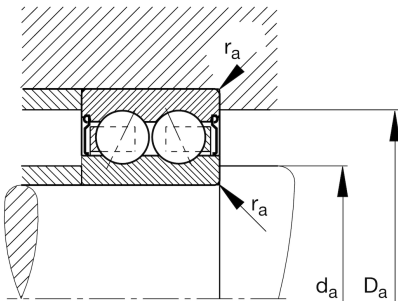
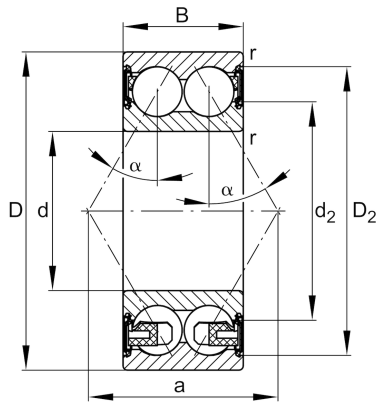

## Temperature range

$T_{\min}$	-20 °C	Operating temperature min.
$T_{\max}$	110 °C	Operating temperature max.
	0,68 kg	Weight

## Main Dimensions &amp; Performance Data

d	50 mm	Bore diameter
D	90 mm	Outside diameter
B	30,2 mm	Width
$C_r$	53.000 N	Basic dynamic load rating, radial
$C_{0r}$	44.000 N	Basic static load rating, radial
$C_{ur}$	3.050 N	Fatigue load limit, radial
$n_G$	5.900 1/min	Limiting speed

## Dimensions

$r_{\min}$	1,1 mm	Minimum chamfer dimension
$D_2$	82,9 mm	Caliber diameter outer ring
$d_2$	62,8 mm	Caliber diameter inner ring
a	53,2 mm	Distance between the apexes of the pressure cones
$\alpha$	30 °	Contact angle

## Mounting dimensions

$d_{a \min}$	57 mm	Minimum diameter shaft shoulder
$D_{a \max}$	83 mm	Maximum diameter of housing shoulder
$r_{a \max}$	1 mm	Maximum fillet radius