

FAG

★ 3310-BD-XL-2HRS-TVH

Angular contact ball bearing

Schaeffler ID:
0631713500000Angular contact ball bearing 33..-BD-
XL-2HRS-TVH, double row, X-life, seals,
plastic cage

★ Preferred product

X-life

Technical information

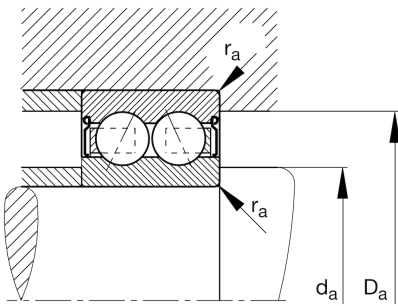

Temperature range

T_{min}	-20 °C	Operating temperature min.
T_{max}	110 °C	Operating temperature max.
	1,78 kg	Weight

Main Dimensions & Performance Data

d	50 mm	Bore diameter
D	110 mm	Outside diameter
B	44,4 mm	Width
C_r	93.000 N	Basic dynamic load rating, radial
C_{0r}	70.000 N	Basic static load rating, radial
C_{ur}	4.850 N	Fatigue load limit, radial
n_G	4.900 1/min	Limiting speed

Dimensions

r_{min}	2 mm	Minimum chamfer dimension
D_2	96,8 mm	Caliber diameter outer ring
d_2	69,1 mm	Caliber diameter inner ring
a	64,2 mm	Distance between the apexes of the pressure cones
α	30 °	Contact angle

Mounting dimensions

$d_{a min}$	61 mm	Minimum diameter shaft shoulder
$D_{a max}$	99 mm	Maximum diameter of housing shoulder
$r_{a max}$	2 mm	Maximum fillet radius