

FAG

★ 3212-BD-XL-2HRS-TVH

Angular contact ball bearing

Schaeffler ID:
0637295200000Angular contact ball bearing 32..-BD-
XL-2HRS-TVH, double row, X-life, seals,
plastic cage

★ Preferred product

X-life

Technical information

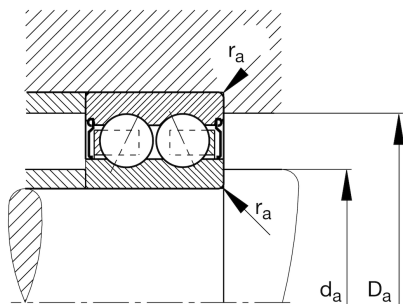

Temperature range

T_{\min}	-20 °C	Operating temperature min.
T_{\max}	110 °C	Operating temperature max.
	1,27 kg	Weight

Main Dimensions & Performance Data

d	60 mm	Bore diameter
D	110 mm	Outside diameter
B	36,5 mm	Width
C_r	75.000 N	Basic dynamic load rating, radial
C_{0r}	64.000 N	Basic static load rating, radial
C_{ur}	4.400 N	Fatigue load limit, radial
n_G	4.750 1/min	Limiting speed

Dimensions

r_{\min}	1,5 mm	Minimum chamfer dimension
D_2	100,5 mm	Caliber diameter outer ring
d_2	76,6 mm	Caliber diameter inner ring
a	64,7 mm	Distance between the apexes of the pressure cones
α	30 °	Contact angle

Mounting dimensions

$d_{a \min}$	69 mm	Minimum diameter shaft shoulder
$D_{a \max}$	101 mm	Maximum diameter of housing shoulder
$r_{a \max}$	1,5 mm	Maximum fillet radius