

FAG
★ F511-A-L

Flanged housing

 Schaeffler ID:
0384387200000

★ Preferred product

 Flanged housing for various bearing types,
with conical bore and clamping sleeve,
closed on one side

Technical information

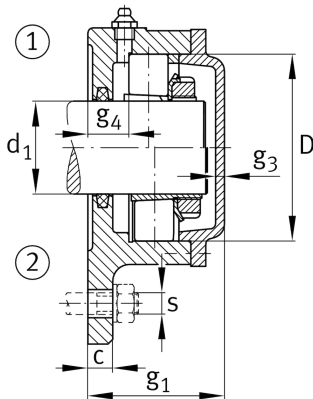
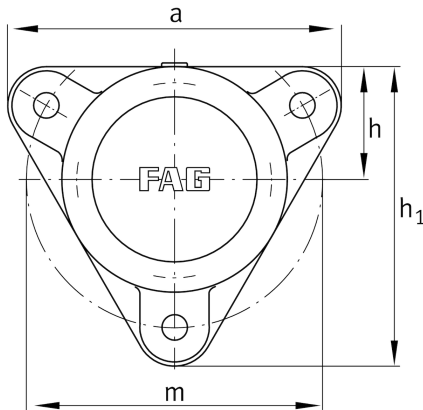
Main Dimensions & Performance Data

d_1	50 mm	Shaft diameter
a	190 mm	Flange width
h_1	170 mm	height flange
g_2	71 mm	total width with cover
	3	number of fastening holes
	4,2 kg	Weight

Dimensions

	M10x1	connection thread lubrication
c	16 mm	thickness of flange
D	100 mm	outside diameter bearing
g_4	23 mm	distance flange to bearing seat
h	65 mm	distance shaft axis
m	170 mm	pitch circle diameter fixing holes
s	M12	size of fixing screws