

**FAG**★ **F516-A-L**

Flanged housing

Schaeffler ID:
0384387630000Flanged housing for various bearing types,
with conical bore and clamping sleeve,
closed on one side

★ Preferred product

Technical information

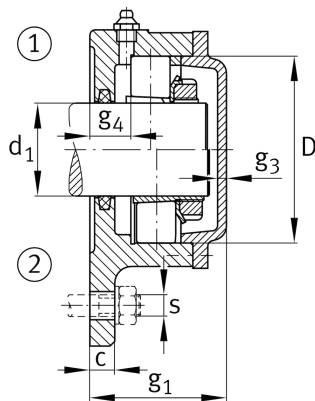
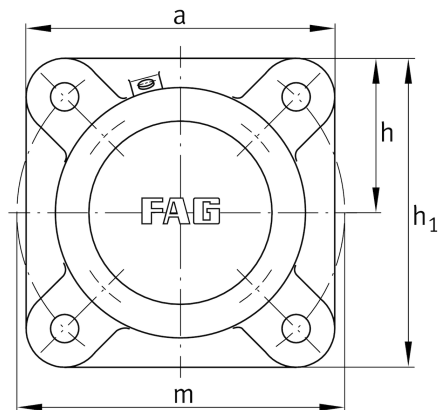
**Main Dimensions & Performance Data**

d_1	70 mm	Shaft diameter
a	196 mm	Flange width
h_1	196 mm	height flange
g_2	101 mm	total width with cover
	4	number of fastening holes
	9,775 kg	Weight

Dimensions

	M10x1	connection thread lubrication
c	25 mm	thickness of flange
D	140 mm	outside diameter bearing
g_4	32 mm	distance flange to bearing seat
h	98 mm	distance shaft axis
m	215 mm	pitch circle diameter fixing holes
s	M16	size of fixing screws